

# ETSI TS 103 300-3 V2.2.1 (2023-02)



**Intelligent Transport Systems (ITS);  
Vulnerable Road Users (VRU) awareness;  
Part 3: Specification of VRU awareness basic service;  
Release 2**

---

**Reference**

RTS/ITS-001963

---

**Keywords**

automotive, ITS, safety, service, transport

**ETSI**

---

650 Route des Lucioles  
F-06921 Sophia Antipolis Cedex - FRANCE

Tel.: +33 4 92 94 42 00 Fax: +33 4 93 65 47 16

Siret N° 348 623 562 00017 - APE 7112B  
Association à but non lucratif enregistrée à la  
Sous-Préfecture de Grasse (06) N° w061004871

---

**Important notice**

The present document can be downloaded from:

<http://www.etsi.org/standards-search>

The present document may be made available in electronic versions and/or in print. The content of any electronic and/or print versions of the present document shall not be modified without the prior written authorization of ETSI. In case of any existing or perceived difference in contents between such versions and/or in print, the prevailing version of an ETSI deliverable is the one made publicly available in PDF format at [www.etsi.org/deliver](http://www.etsi.org/deliver).

Users of the present document should be aware that the document may be subject to revision or change of status.

Information on the current status of this and other ETSI documents is available at

<https://portal.etsi.org/TB/ETSIDeliverableStatus.aspx>

If you find errors in the present document, please send your comment to one of the following services:

<https://portal.etsi.org/People/CommitteeSupportStaff.aspx>

If you find a security vulnerability in the present document, please report it through our  
Coordinated Vulnerability Disclosure Program:

<https://www.etsi.org/standards/coordinated-vulnerability-disclosure>

---

**Notice of disclaimer & limitation of liability**

The information provided in the present deliverable is directed solely to professionals who have the appropriate degree of experience to understand and interpret its content in accordance with generally accepted engineering or other professional standard and applicable regulations.

No recommendation as to products and services or vendors is made or should be implied.

No representation or warranty is made that this deliverable is technically accurate or sufficient or conforms to any law and/or governmental rule and/or regulation and further, no representation or warranty is made of merchantability or fitness for any particular purpose or against infringement of intellectual property rights.

In no event shall ETSI be held liable for loss of profits or any other incidental or consequential damages.

Any software contained in this deliverable is provided "AS IS" with no warranties, express or implied, including but not limited to, the warranties of merchantability, fitness for a particular purpose and non-infringement of intellectual property rights and ETSI shall not be held liable in any event for any damages whatsoever (including, without limitation, damages for loss of profits, business interruption, loss of information, or any other pecuniary loss) arising out of or related to the use of or inability to use the software.

---

**Copyright Notification**

No part may be reproduced or utilized in any form or by any means, electronic or mechanical, including photocopying and microfilm except as authorized by written permission of ETSI.

The content of the PDF version shall not be modified without the written authorization of ETSI.

The copyright and the foregoing restriction extend to reproduction in all media.

© ETSI 2023.  
All rights reserved.

# Contents

Intellectual Property Rights .....	6
Foreword.....	6
Modal verbs terminology.....	6
Executive summary .....	6
Introduction .....	8
1 Scope .....	9
2 References .....	9
2.1 Normative references .....	9
2.2 Informative references.....	10
3 Definition of terms, symbols and abbreviations.....	10
3.1 Terms.....	10
3.2 Symbols.....	11
3.3 Abbreviations .....	11
4 VRU basic service introduction .....	12
4.1 Background .....	12
4.2 Services provided by VRU basic service .....	13
5 VRU basic service functional description .....	14
5.1 VRU basic service in the ITS architecture .....	14
5.2 VRU basic service functional architecture .....	15
5.3 Interfaces of the VRU basic service .....	17
5.3.1 VRU basic service interfaces in the facilities layer (IF.OFa) .....	17
5.3.2 Interface to the ITS applications (IF.FA).....	17
5.3.3 Interface to the ITS-S networking and transport layer (IF.NF).....	18
5.3.3.1 General requirements .....	18
5.3.3.2 Interface to the GeoNetworking/BTP stack .....	18
5.3.3.3 Interface to the IPv6 stack and the combined IPv6/GeoNetworking stack .....	19
5.3.4 Interface to the ITS-S management entity (IF.MF) .....	20
5.3.5 Interface to the ITS-S security entity (IF.SF) .....	20
5.4 VRU cluster specification .....	20
5.4.1 VRU clustering functional overview .....	20
5.4.2 VRU cluster operation .....	22
5.4.2.1 VBS clustering states .....	22
5.4.2.2 Events triggering a transition between VBS clustering states.....	22
5.4.2.3 Events not triggering a transition between VBS clustering states.....	24
5.4.2.4 Conditions for clustering operations .....	25
5.4.2.5 State diagram related to VRU cluster operation.....	26
5.4.2.6 Application to the specific case of a combined VRU.....	26
5.4.3 Cluster information parameters.....	27
6 VAM dissemination .....	27
6.1 VAM transmission method.....	27
6.2 Frequency/Periodicity range of VAMs.....	28
6.3 Transmitting VAMs .....	28
6.4 Triggering conditions .....	28
6.4.1 Individual VAM transmission management by VBS at VRU ITS-S.....	28
6.4.2 Cluster VAM transmission management by VBS at VRU ITS-S.....	29
6.4.3 VAM Redundancy Mitigation .....	30
6.4.4 VAM time requirement.....	31
6.4.4.1 VAM generation time .....	31
6.4.4.2 VAM timestamp.....	31
6.5 Security constraints .....	31
6.5.1 Introduction.....	31
6.5.2 Service Specific Permissions (SSP).....	31

6.5.3	Certificate attachment policy .....	32
6.5.4	Privacy considerations .....	32
6.6	Methods to prevent false warnings (false positives).....	33
6.6.1	General Considerations.....	33
6.6.2	Roadworks safety.....	34
6.6.3	Weather condition.....	34
6.7	Methods to prevent false negatives .....	35
7	VAM Format Specification .....	36
7.1	General Structure of a VAM PDU .....	36
7.2	ITS PDU header .....	37
7.3	Other containers .....	37
7.3.1	Basic container.....	37
7.3.2	VRU specific containers .....	37
7.3.3	VAM VRU HF container.....	38
7.3.4	VAM VRU LF container .....	39
7.3.5	VAM VRU cluster containers.....	41
7.3.6	VAM VRU Motion Prediction container.....	43
7.4	Special container for VRU Profile 3 (motorcyclist).....	43
7.5	VAM format and coding rules.....	44
7.5.1	Common data dictionary.....	44
7.5.2	VAM data presentation.....	44
8	Parameters values.....	44
<b>Annex A (normative):</b>	<b>ASN.1 specification of VAM .....</b>	<b>48</b>
<b>Annex B (normative):</b>	<b>Description of data elements and data frames .....</b>	<b>49</b>
<b>Annex C (informative):</b>	<b>Protocol operation of the VRU basic service .....</b>	<b>50</b>
C.1	Introduction .....	50
C.2	Originating ITS-S operation .....	50
C.2.1	Protocol data setting rules .....	50
C.2.2	T_CheckVamGen.....	50
C.2.3	Protocol data.....	50
C.2.4	General protocol operation .....	51
C.2.5	VAM construction exception .....	51
C.3	Receiving ITS-S operation .....	51
C.3.1	Protocol data setting rules .....	51
C.3.2	General protocol operation.....	51
C.3.3	Exception handling.....	52
C.4	VBS protocol flowcharts.....	52
<b>Annex D (informative):</b>	<b>Recommendation for CAM VRU special container applicable to VRUs Profile 3.....</b>	<b>54</b>
D.1	General consideration.....	54
D.2	MotorcyclistContainer.....	54
<b>Annex E:</b>	<b>Void .....</b>	<b>55</b>
<b>Annex F:</b>	<b>Void .....</b>	<b>56</b>
<b>Annex G (informative):</b>	<b>Additional elements for further study on VRU behaviour prediction .....</b>	<b>57</b>
G.0	Disclaimer .....	57
G.1	Overview .....	57
G.2	VRU Motion Dynamic Change Indications (MDCI) .....	58
G.3	VRU Behaviour learning aspects .....	60

<b>Annex H (informative):</b>	<b>Application to use case UC-B1: Active Roadworks .....</b>	<b>63</b>
<b>Annex I (informative):</b>	<b>Non VRU ITS-S VAM Dissemination .....</b>	<b>64</b>
I.1	Introduction .....	64
I.2	Rationale.....	64
I.3	Light weight dynamic road occupancy map.....	65
I.4	Text Proposal.....	66
I.4.0	How to read this clause .....	66
I.4.1	Update of clause 6.3: Transmitting VAMs.....	66
I.4.2	Text for additional clause (to be inserted after clause 6.4.2): VAM Transmission Management by VBS at Non-VRU ITS-S.....	67
I.4.3	Additional clause after clause 7.3.6: VAM Extension container .....	69
I.4.4	Update of annex A (normative): ASN.1 specification of VAM .....	69
History .....		71

---

# Intellectual Property Rights

## Essential patents

IPRs essential or potentially essential to normative deliverables may have been declared to ETSI. The declarations pertaining to these essential IPRs, if any, are publicly available for **ETSI members and non-members**, and can be found in ETSI SR 000 314: "*Intellectual Property Rights (IPRs); Essential, or potentially Essential, IPRs notified to ETSI in respect of ETSI standards*", which is available from the ETSI Secretariat. Latest updates are available on the ETSI Web server (<https://ipr.etsi.org/>).

Pursuant to the ETSI Directives including the ETSI IPR Policy, no investigation regarding the essentiality of IPRs, including IPR searches, has been carried out by ETSI. No guarantee can be given as to the existence of other IPRs not referenced in ETSI SR 000 314 (or the updates on the ETSI Web server) which are, or may be, or may become, essential to the present document.

## Trademarks

The present document may include trademarks and/or tradenames which are asserted and/or registered by their owners. ETSI claims no ownership of these except for any which are indicated as being the property of ETSI, and conveys no right to use or reproduce any trademark and/or tradename. Mention of those trademarks in the present document does not constitute an endorsement by ETSI of products, services or organizations associated with those trademarks.

**DECT™**, **PLUGTESTS™**, **UMTS™** and the ETSI logo are trademarks of ETSI registered for the benefit of its Members. **3GPP™** and **LTE™** are trademarks of ETSI registered for the benefit of its Members and of the 3GPP Organizational Partners. **oneM2M™** logo is a trademark of ETSI registered for the benefit of its Members and of the oneM2M Partners. **GSM®** and the GSM logo are trademarks registered and owned by the GSM Association.

---

# Foreword

This Technical Specification (TS) has been produced by ETSI Technical Committee Intelligent Transport Systems (ITS).

The present document is part 3 of a multi-part deliverable. Full details of the entire series can be found in part 1 [i.1].

---

# Modal verbs terminology

In the present document "**shall**", "**shall not**", "**should**", "**should not**", "**may**", "**need not**", "**will**", "**will not**", "**can**" and "**cannot**" are to be interpreted as described in clause 3.2 of the [ETSI Drafting Rules](#) (Verbal forms for the expression of provisions).

"**must**" and "**must not**" are **NOT** allowed in ETSI deliverables except when used in direct citation.

---

# Executive summary

The standard for Vulnerable Road Users (VRU) awareness is split into three documents:

- ETSI TR 103 300-1 [i.1] provides a definition of the Vulnerable Road Users (VRU) system and its components. It describes and categorizes typical use cases relevant to traffic safety that involve road users such as pedestrians, bicyclists, e-scooters, motorcycles, animals and road workers and are enabled by Cooperative Intelligent Transport Systems. The Technical Report concludes with a preliminary analysis of the challenges to be solved by the VRU awareness basic service.
- ETSI TS 103 300-2 [1] defines the VRU related requirements, as well as the functional architecture of the VRU system. In addition, the content of this specification analyses the impact of use cases, requirements and functional architecture on existing standards (for instance the CAM European Standard [6]).

- The present document specifies the VRU awareness Basic Service (VBS) that has been introduced in the architecture of the VRU system defined in ETSI TS 103 300-2 [1].

The objective of the VBS service is to enable the transmission and reception of VRU Awareness Messages (VAM) to enhance the protection of road users such as pedestrians, bicyclists, motorcyclists as well as animals that may pose a safety risk to other road users.

The present document specifies the operation of the VBS inside the ITS station, including in the case when they group into clusters with similar behaviour, the conditions for disseminating the VAM and the VAM format, semantics and syntax. The present document delivers a toolbox intended to fulfil the VBS objective. The VBS and the VAM are expected to be included in the C-ITS framework, which is under the responsibility of the application developers.

Clause 4 introduces the context of the VBS, explains the basic principles of the VAM and recalls a few definitions from ETSI TS 103 300-2 [1], for example the VRU categorization into four profiles of road users. It introduces the different services provided by the VBS: handling the VRU role to activate the VBS operations only when the device owner is indeed a VRU, sending and receiving VAMs.

Clause 5 provides a more detailed description of the VRU basic service. It explains how the VBS is positioned within the facilities layer of the ITS station architecture. It describes the internal functional architecture of the VBS, with the following main functions: VRU basic service management, VRU cluster management, VAM transmission management and encoding, and the VAM decoding and reception management. All the interactions between the VBS and other functions of the facilities layer, other ITS-S layers such as applications and Networking and Transport layer, as well as management and security entities are presented. Finally, this clause specifies the operation of the VBS in case of VRU clusters, i.e. how to create, join, leave and breakup VRU clusters.

Clause 6 specifies the different conditions for the VAM dissemination: transmission method using broadcast, as specified in ETSI TS 103 300-2 [1] and the periodicity of the VAM transmission. Triggering conditions are detailed, for individual VAMs sent by individual VRUs on their own, or cluster VAMs sent by the cluster leader on behalf of the other devices located inside the cluster. In addition to the clustering operation, specific rules apply to mitigate the redundancy of information in the radio channel and prevent the VRU device to send the VAM under certain conditions. Security constraints and methods to prevent false warning are presented to enhance trust into VAMs, including certificate attachment policy and privacy considerations.

Clause 7 provides the format and coding rules of the VAM, which is specified in more detail in annex A (ASN.1 coding), and annex B (definition of the different parameters in each container).

Clause 8 collects the numerical values to be applied to the various parameters introduced in the previous clauses for VRU clustering decisions, membership handling, VAM generation and triggering conditions.

Annex C provides a timer-controlled approach for the VBS protocol operation as one potential variant compliant, considering both the originating and the receiving ITS-S operation.

ETSI TS 103 300-2 [1] specifies that VRU belonging to the VRU profile 3 (motorcycles) should not transmit the VAM, as it includes data which are already transmitted in the CAM by these vehicles. Yet, these are considered as VRUs and would benefit from an increased awareness from other road users. Annex D recommends the inclusion of a special vehicle container into the CAM sent by these VRUs.

Annex G proposes additional elements for further study on VRU behaviour learning and potential transitions between different VRU profiles.

Annex H gives an example of implementation in the case of active road workers.

Annex I proposes a future extension of the present document to enable the dissemination of the VAM by non VRU ITS-S. This would be helpful to integrate non-equipped VRUs in the VRU C-ITS architecture specified in ETSI TS 103 300-2 [1].

---

## Introduction

Cooperative awareness within road traffic means that road users and roadside infrastructure are informed about each other's position, dynamics and attributes. Road users are all kind of road vehicles like cars, trucks, motorcycles, bicycles or even pedestrians and roadside infrastructure equipment including road signs, traffic lights or barriers and gates. The awareness of each other is the basis for several road safety and traffic efficiency applications. It is achieved by regular exchange of information among vehicles, pedestrians and road-side infrastructure based on wireless networks, called V2X network and as such it can be considered part of Intelligent Transport Systems (ITS). An integral part of road ITS are the class of vulnerable road users including pedestrians, bicyclists, motorcyclists and animals. In order to efficiently participate in the road safety related ITS communication a continuous repeated awareness message is transmitted by these vulnerable road users using the Vulnerable Road Users Awareness Message (VAM).

The construction, management and processing of VAMs is done by the Vulnerable Road Users basic service (VRU basic service), which is part of the facilities layer within the ITS communication architecture defined in ETSI TS 103 898 [i.11] .

The present document has been subject to a major revision between V2.1.2 and V2.2.1 to align with the update of the ITS Common Data Dictionary (ETSI TS 102 894-2 [7]) from V1.3.1 to V2.1.1. It is in Stage 4 of its lifecycle.

The present document is not yet fully Release 2 compliant as the Release 2 framework is still under discussion at the time of preparation of the present version of the present document. The compliance will be achieved in the next revision.



---

# 1 Scope

The present document defines the communication protocols, message format, semantics and syntax as well as key interfaces and protocol operation for the VRU awareness service, hereafter named the VRU Basic Service (VBS).

---

## 2 References

### 2.1 Normative references

References are either specific (identified by date of publication and/or edition number or version number) or non-specific. For specific references, only the cited version applies. For non-specific references, the latest version of the referenced document (including any amendments) applies.

Referenced documents which are not found to be publicly available in the expected location might be found at <https://docbox.etsi.org/Reference>.

NOTE: While any hyperlinks included in this clause were valid at the time of publication, ETSI cannot guarantee their long term validity.

The following referenced documents are necessary for the application of the present document.

- [1] ETSI TS 103 300-2: "Intelligent Transport Systems (ITS); Vulnerable Road Users (VRU) awareness; Part 2: Functional Architecture and Requirements definition; Release 2".
- [2] Void.
- [3] ETSI TS 103 836-5-1: "Intelligent Transport Systems (ITS); Vehicular Communications; GeoNetworking; Part 5: Transport Protocols; Sub-part 1: Basic Transport Protocol; Release 2".
- [4] ETSI EN 302 890-2: "Intelligent Transport Systems (ITS); Facilities Layer function; Part 2: Position and Time management (PoTi); Release 2".
- [5] ETSI TS 103 938: "Intelligent Transport Systems (ITS); Vehicular Communications; Basic Set of Applications; Local Dynamic Map (LDM); Release 2".
- [6] ETSI TS 103 900: "Intelligent Transport Systems (ITS); Vehicular Communications; Basic Set of Applications; Specification of Cooperative Awareness Basic Service; Release 2".
- [7] ETSI TS 102 894-2: "Intelligent Transport Systems (ITS); Users and applications requirements; Part 2: Applications and facilities layer common data dictionary; Release 2".
- [8] ETSI TS 103 097: "Intelligent Transport Systems (ITS); Security; Security header and certificate formats; Release 2".
- [9] ETSI TS 102 965: "Intelligent Transport Systems (ITS); Application Object Identifier (ITS-AID); Registration; Release 2".
- [10] Void.
- [11] ETSI TS 103 574: "Intelligent Transport Systems (ITS); Congestion Control Mechanisms for C-V2X PC5 interface; Access layer part; Release 2".
- [12] ETSI TS 102 731: "Intelligent Transport Systems (ITS); Security; Security Services and Architecture; Release 2".
- [13] Void.
- [14] Void.
- [15] ISO 8855:2011: "Road vehicles -- Vehicle dynamics and road-holding ability -- Vocabulary".

- [16] Recommendation ITU-T X.691/ISO/IEC 8825-2 (1997-12): "Information technology - ASN.1 encoding rules: Specification of Packed Encoding Rules (PER)".

## 2.2 Informative references

References are either specific (identified by date of publication and/or edition number or version number) or non-specific. For specific references, only the cited version applies. For non-specific references, the latest version of the referenced document (including any amendments) applies.

NOTE: While any hyperlinks included in this clause were valid at the time of publication, ETSI cannot guarantee their long-term validity.

The following referenced documents are not necessary for the application of the present document but they assist the user with regard to a particular subject area.

- [i.1] ETSI TR 103 300-1: "Intelligent Transport Systems (ITS); Vulnerable Road Users (VRU) awareness; Part 1: Use Cases definition; Release 2".
- [i.2] ETSI TS 103 836-4-1: "Intelligent Transport Systems (ITS); Vehicular Communications; GeoNetworking; Part 4: Geographical addressing and forwarding for point-to-point and point-to-multipoint communications; Sub-part 1: Media-Independent Functionality; Release 2".
- [i.3] ETSI TS 103 836-3: "Intelligent Transport Systems (ITS); Vehicular Communications; GeoNetworking; Part 3: Network Architecture; Release 2".
- [i.4] ETSI TS 102 894-1: "Intelligent Transport Systems (ITS); Users and applications requirements; Part 1: Facility layer structure, functional requirements and specifications; Release 2".
- [i.5] ETSI TS 102 723-11: "Intelligent Transport Systems (ITS); OSI cross-layer topics; Part 11: Interface between networking and transport layer and facilities layer; Release 2".
- [i.6] ETSI TS 102 723-5: "Intelligent Transport Systems (ITS); OSI cross-layer topics; Part 5: Interface between management entity and facilities layer; Release 2".
- [i.7] ISO EN 17419: "Intelligent Transport Systems -- Cooperative Systems -- Classification and management of ITS applications in a global context".
- [i.8] ETSI TS 102 723-8: "Intelligent Transport Systems (ITS); OSI cross-layer topics; Part 8: Interface between security entity and network and transport layer; Release 2".
- [i.9] SAE J3194: "Taxonomy and Classification of Powered Micro mobility Vehicles".
- [i.10] SAE J2945/9: "Vulnerable Road User Safety Message Minimum Performance Requirements".
- [i.11] ETSI TS 103 898: "Intelligent Transport Systems (ITS); Communications Architecture; Release 2".
- [i.12] ETSI TS 103 301: "Intelligent Transport Systems (ITS); Vehicular Communications; Basic Set of Applications; Facilities layer protocols and communication requirements for infrastructure services; Release 2".

---

## 3 Definition of terms, symbols and abbreviations

### 3.1 Terms

For the purposes of the present document, the terms given in ETSI TR 103 300-1 [i.1], ETSI TS 103 300-2 [1] and the following apply:

**cluster VAM:** Vulnerable Road User (VRU) Awareness Message (VAM) including information about a cluster of VRUs

**farm animal:** animal living under the supervision of an owner

**individual VAM:** Vulnerable Road User (VRU) Awareness Message (VAM) including information about an individual VRU

NOTE: A VAM without any further qualification can indifferently be a cluster VAM or an individual VAM.

**low-risk geographical area:** area part of the road infrastructure where the safety related traffic context is relaxed for VRUs such as pedestrian areas as described in use case UC-F1 in ETSI TR 103 300-1 [i.1]

NOTE 1: Locations where the device holder is not considered as a VRU (e.g. inside a building, inside a public transport) are not considered as low-risk geographical areas but instead as "zero-risk" geographical areas.

NOTE 2: VRUs may learn about these areas through their navigation application or when receiving a corresponding MAPEM (see ETSI TS 103 301 [i.12]). Low-risk geographical areas are expected to be signalled as low risk by a relevant authority. In the case when motor vehicles are allowed to enter such an area, it is generally under their own responsibility to enforce special restrictions such a low speed limitation.

**service animal:** animal which supports a specific service to a human, like a guiding dog or a police horse without person

**wild animal:** animal living without any supervision

## 3.2 Symbols

Void.

## 3.3 Abbreviations

For the purposes of the present document, the abbreviations given in ETSI TR 103 300-1 [i.1], ETSI TS 103 300-2 [1] and the following apply:

BTP	Basic Transport Protocol
CA	Cooperative Awareness (basic service)
CAM	Cooperative Awareness Message
CDD	Common Data Dictionary
CPM	Collective Perception Message
CPS	Collective Perception Service
DCC	Decentralized Congestion Control
DDP	Device Data Provider
DENM	Decentralized Environmental Notification Message
FA-SAP	Facilities Application SAP
FL-SDU	Facilities Layer-Service Data Unit
ITS	Intelligent Transport Systems
ITS-AID	ITS Application Identifier
ITS-S	ITS Station
MAC	Medium Access Control
MAPEM	MAP (topology) Extended Message
MF-SAP	Management Facilities SAP
MIB	Management Information Base
NF-SAP	Networking and transport Facilities SAP
PCI	Protocol Control Information
PoTi	Position and Time
PTW	Powered Two Wheelers
RF	Radio Frequency
R-ITS-S	Roadside ITS Station
RLT	Road and Lane Topology
SAP	Service Access Point
SF-SAP	Security Facilities SAP
TLM	Traffic Light Manoeuvre

UC	Use Case
VAM	VRU Awareness Message
VBS	VRU Basic Service
V-ITS-S	Vehicle ITS Station (VRU or non-VRU)
VRU	Vulnerable Road User

## 4 VRU basic service introduction

### 4.1 Background

ETSI TS 103 300-2 [1] specifies the requirements for the C-ITS service related to VRU protection, as well as the VRU system architecture. The present document further elaborates on the details of the VRU basic service and the transmission of the Vulnerable Road User Awareness Messages (VAMs). VAMs are messages transmitted from VRU ITS-S to create and maintain awareness of vulnerable road users participating in the VRU system.

VRU ITS-S shall always use the VAM, while other ITS-S including infrastructure and vehicle ITS-S can use CPM to signal the identified presence of a VRU in the vicinity. The relevant use cases are depicted in ETSI TR 103 300-1 [i.1]. If their configuration permits, VRU ITS-S shall be capable of receiving CPMs in order to get the full environment awareness. Infrastructure ITS-S and vehicular ITS-S should be capable of receiving VAMs. The information included in the VAM can be used to enhance their overall perception.

A VAM contains status and attribute information of the originating VRU ITS-S. The content may vary depending on the profile of the VRU ITS-S. VRU Profiles are specified in ETSI TS 103 300-2 [1] and reminded below. A typical status information includes time, position, motion state, cluster status, etc. Typical attribute information includes data about the VRU profile, type, dimensions, etc. On reception of a VAM the receiving ITS-S becomes aware of the presence, type, and status of the originating VRU ITS-S. The received information can be used by the receiving ITS-S to support several VRU related ITS applications. For example, by comparing the status of the originating VRU ITS-S with its own status, a receiving ITS-S is able to estimate the collision risk with the originating VRU ITS-S and may inform the ITS-S user via the HMI.

The VRU Basic Service (VBS) is the facilities layer entity supporting ITS applications for the transmission and reception of the VAM message. Multiple ITS applications may rely on the VRU basic service. It is assigned to domain application support facilities in ETSI TS 102 894-1 [i.4].

Besides the support of applications, the awareness of other ITS-S gained by the VRU basic service may be used in the networking & transport layer for the position dependent dissemination of messages, e.g. DENM by GeoBroadcasting as specified in ETSI TS 103 836-4-1 [i.2]. The generation and transmission of VAM is managed by the VRU basic service by implementing the VAM protocol.

As a reminder, the following VRU profiles are specified in clause 6.1 of ETSI TS 103 300-2 [1]:

- VRU Profile 1 - Pedestrian. Typical VRUs in this profile: pedestrians, i.e. road users not using a mechanical device for their trip. It includes for example pedestrians on a pavement, but also children, prams, disabled persons, blind persons guided by a dog, elderly persons, persons walking beside their bicycle.
- VRU Profile 2 - Bicyclist. Typical VRUs in this profile: bicyclists and similar e.g. light vehicles riders, possibly with an electric engine. It includes bicyclists, but also wheelchair users, horses carrying a rider, skaters, e-scooters, personal transporters, etc.
- VRU Profile 3 - Motorcyclist. Typical VRUs in this profile: motorcyclists, which are equipped with engines that allow them to move on the road. It includes users (driver and passengers, e.g. children and animals) of Powered Two Wheelers (PTW) such as mopeds (motor scooters), motorcycles or side-cars.
- VRU Profile 4 - Animal. Animals presenting a safety risk to other road users. Typical VRUs in this profile: dogs, wild animals, horses, cows, sheep, etc. Some of these VRUs might have their own ITS-S (e.g. dog in a city or a horse) but most of the VRUs in this profile will not be able to send the VAM and only be indirectly detected, especially wild animals in rural areas and highway situations.

NOTE: A VRU vehicle itself does not represent a VRU but only the combination with at least one person will create the VRU.

## 4.2 Services provided by VRU basic service

The VRU basic service is a facilities layer entity that operates the VAM protocol. It provides three main services: handling the VRU role, sending and receiving of VAMs.

The VRU basic service uses the services provided by the protocol entities of the ITS networking & transport layer to disseminate the VAM.

### Handling VRU role

The VBS receives unsolicited indications from the VRU profile management entity (see clause 6.4 in ETSI TS 103 300-2 [1]) on whether the device user is in a context where it is considered as a VRU (e.g. pedestrian crossing a road) or not (e.g. passenger in a bus). The VBS remains operational in both states, as defined in Table 1.

**Table 1: Possible roles of the VRU during VRU basic service operation**

VRU role	Specification	Valid VRU profiles	Valid VRU types	Additional explanation
VRU_ROLE_ON	The device user is considered as a VRU. Based on information received from VRU profile management entity, the VBS shall check the type of VRU and the profile of VRU. It shall also handle the VBS clustering state and provide services to other entities, as defined in clause 5.	ALL	ALL	The VBS state should be changed according to the condition of VRU device user as notified by the VRU profile Management entity. The VRU device can send VAMs, receive VAMs, or both while checking the position of VRU device user through the PoTi entity. Except for VRUs of profile 3, it may execute the VRU clustering functions (see clause 5).
VRU_ROLE_OFF	The device user is not considered as a VRU. The VRU device shall neither send nor receive VAMs.	ALL	ALL	The VRU is located in a "zero-risk" geographical area, for example in a bus, in a passenger car, etc. The VBS remains operational in this state to monitor any notification that the role has changed to VRU_ROLE_ON.
NOTE: There may be cases where the VRU profile management entity provides invalid information, e.g. the VRU device user is considered as a VRU, while its role should be VRU_ROLE_OFF. This is implementation dependent, as the receiving ITS-S should have very strong plausibility check and take into account the VRU context during their risk analysis. The precision of the positioning system (both at transmitting and receiving side) would also have a strong impact on the detection of such cases.				

### Sending VAMs

Sending of VAMs consists of two activities: generation of VAMs and transmission of VAMs.

In VAM generation, the originating ITS-S composes the VAM, which is then delivered to the ITS networking and transport layer for dissemination.

In VAM transmission, the VAM is transmitted over one or more communications media using one or more transport and networking protocols. A natural model is for VAMs to be sent by the originating ITS-S to all ITS-Ss within the direct communication range.

VAMs are generated at a frequency determined by the controlling VRU basic service in the originating ITS-S. If a VRU ITS-S is not in a cluster, or is the leader of a cluster, it transmits the VAM periodically. VRU ITS-S that are in a cluster, but not the leader of a cluster, do not transmit the VAM. The generation frequency is determined based on the change of kinematic state, location of the VRU ITS-S, and congestion in the radio channel.

Security measures such as authentication are applied to the VAM during the transmission process in coordination with the security entity.

### Receiving VAMs

Upon receiving a VAM, the VRU basic service makes the content of the VAM available to the ITS applications and/or to other facilities within the receiving ITS-S, such as a Local Dynamic Map (LDM). It applies all necessary security measures such as relevance or message integrity check in coordination with the security entity.

---

## 5 VRU basic service functional description

### 5.1 VRU basic service in the ITS architecture

Figure 1 presents the main components of the ITS-S architecture that directly impact the VRU system operation.

The VRU Basic Service (VBS) shall be a facilities layer entity of the ITS-S architecture. Functions other than those shown in the figure may be present as defined in ETSI TS 102 894-1 [i.4] and support the operation of this service, e.g. the communication support facilities. Figure 1 also presents the interfaces mapped to the ITS-S architecture. The VRU basic service is responsible for transmitting the VAM message, to identify whether the VRU is part of a cluster and to enable the assessment of the potential risk of collision by ITS applications. The VRU basic service consumes data from and provides data to other services located in the facilities layer in order to collect relevant information for VAM generation and to forward the received VAM content for further processing.

ITS-S facilities layer entities for the collection of data shall be the Device Data Provider (DDP) and the Position and Time management (PoTi) and for received data the Local Dynamic Map (LDM) as receiving terminal. The DDP provides the device status information obtained from its local perception entities (see ETSI TS 103 300-2 [1]). The PoTi, specified in ETSI EN 302 890-2 [4] shall provide the position of the ITS-S and time information. The LDM as specified in ETSI TS 103 938 [5] is a database in the ITS-S, which shall be updated with received VAM data. The VRU basic service may also interact with other services in the ITS-S facilities layer: the DCC-FAC, to set the VAM duty cycle, the CA basic service to provide information for the motorcycle special container, the Collective Perception Service (CPS) to receive CPMs, the Road and Lane Topology (RLT) service to receive MAPEMs and the Traffic Light Manoeuvre service to receive SPATEMs.

The VBS shall interact through the MF-SAP (see facilities layer interfaces in ETSI TS 103 898 [i.11]) with the VRU profile management entity in the Management entity to learn whether the ITS-S has the VRU role, which are the VRU profile and type (see ETSI TS 103 300-2 [1]), whether it acts as a single VRU or leader of a VRU cluster, etc. The VBS shall also interact through the MF-SAP to select the best available network and communication profile (transport, network and access layer) to be used for the VAM broadcasting.

The VRU basic service interfaces through:

- the NF-SAP with the networking & transport layer (N&T) for exchanging of VAM messages with other ITS-S;
- the SF-SAP with the Security entity to access security services for VAM transmission and VAM reception;
- the FA-SAP with the application layer if received VAM data are provided directly to the applications;
- the MF-SAP with the management entity as explained above.

The functionalities of the VRU basic service are defined in clause 5.2, the interfaces illustrated in Figure 1 are defined in clause 5.3.

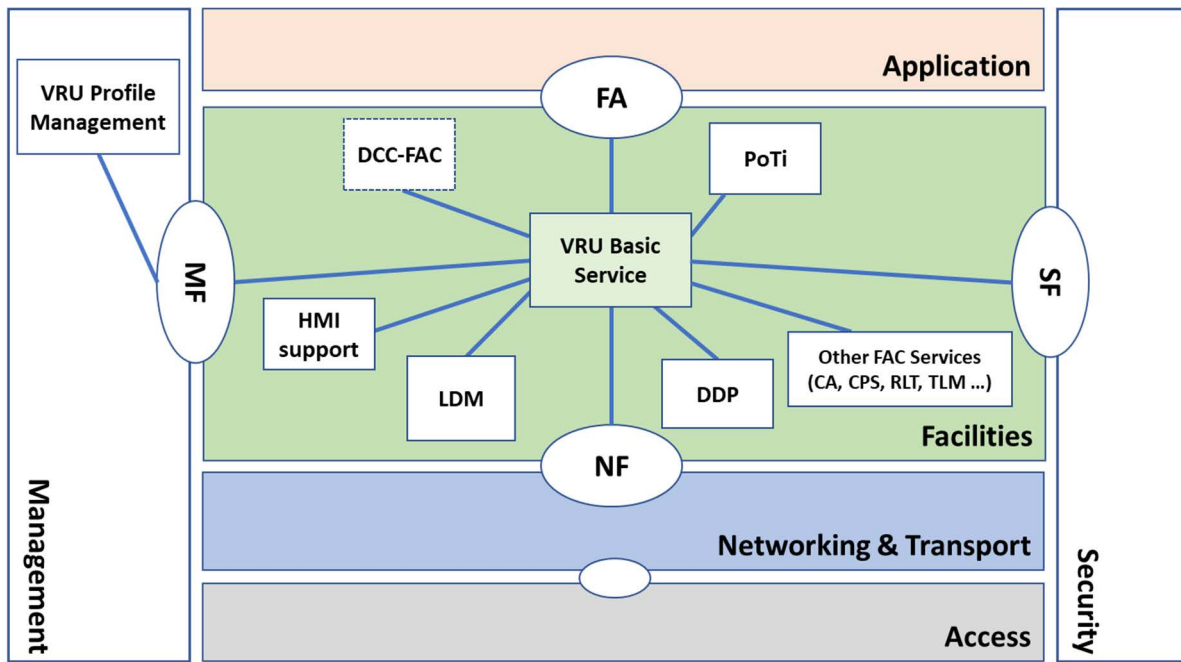
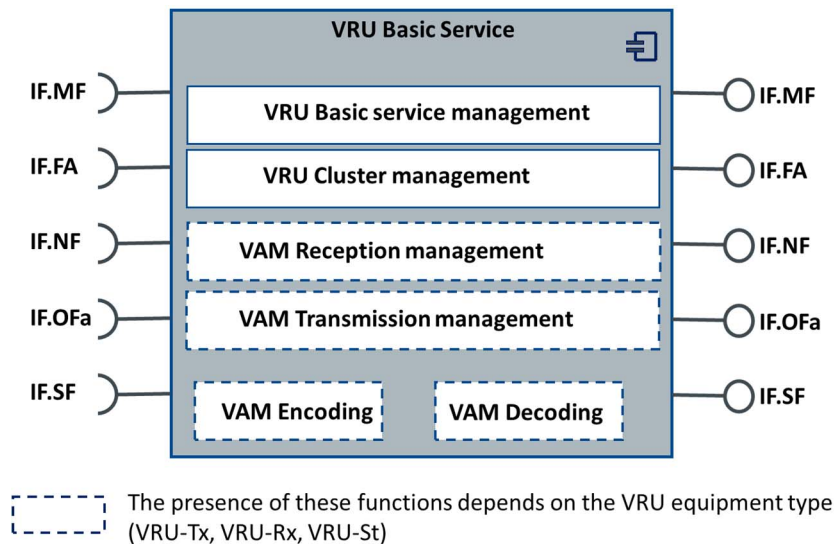

Figure 1: VRU basic service within the ITS-S architecture

## 5.2 VRU basic service functional architecture

This clause provides a summary of the VRU basic service. The VRU basic service functions are represented in Figure 2. This clause introduces these VBS functions, which are further detailed in the next clauses of the present document.



NOTE 1: The VAM reception management and the VAM decoding functions are only present in VRU equipment types VRU-Rx and VRU-St.

NOTE 2: The VAM transmission management and the VAM encoding functions are only present in VRU equipment types VRU-Tx and VRU-St.

NOTE 3: The IF.OFa (interfaces to other facilities) are implementation dependent.

Figure 2: VRU basic service functions

### VRU basic service management

The VRU basic service management shall execute the following functions (see ETSI TS 103 300-2 [1]):

- Store assigned ITS-AID and port number(s) to be used for the VRU basic service.

- Store the VRU configuration received at ITS-S initialization time or updated later for the coding of VAM data elements.
- Manage the interaction with other basic services, e.g. PoTi and DDP.
- Receive information from and transmit information to the HMI, depending on the VRU profile.
- Activate/deactivate the VAM transmission according to the VRU profile management parameters.
- Manage the triggering condition for VAM transmission taking into account the network congestion control rules, as specified in ETSI TS 103 300-2 [1].

### **VRU cluster management**

When implemented, the VRU cluster management function shall execute the following functions (see clause 5.4 for further details):

- Detect if the associated VRU has the capability to become the leader of a cluster.
- Manage the VRU cluster or combined cluster creation and breaking up.
- Compute and store the cluster parameters for the coding of VAM data elements specific to the cluster.
- Detect if the associated VRU should join or leave a cluster.
- Manage the VBS state machine associated to the VRU according to detected cluster events.
- Activate or de-activate the transmission of VAMs according to the VBS clustering state.

### **VAM decoding**

The VAM decoding function shall extract the relevant data elements contained in the received VAM. These data elements are then communicated to the VAM reception management function.

The VAM decoding function is available only if the VAM reception management function is available.

### **VAM reception management**

The VAM reception management function shall execute the following functions after VAM messages decoding:

- Check the relevance of the received message according to its current mobility characteristics and state.
- Determine whether the received message and its security "envelope" meet all the relevant security conditions, including consistency, plausibility and cryptographic integrity.
- Delete or store the received message data elements in the LDM according to previous operations results.

In the VRU-ITS-S, the presence of this function shall depend on the VRU equipment type (see ETSI TR 103 300-1 [i.1]) and shall be provided to the VBS with its initial configuration (see VRU profile management function in clause 6.5.12 of ETSI TS 103 300-2 [1]). For example, VRUs of type VRU-TX will not include the VAM reception management function.

### **VAM transmission management**

The VAM transmission management function shall perform the following operations upon request of the VRU basic service management function:

- Assemble the VAM data elements complying with the message specification.
- Send the constructed VAM to the VAM encoding function.

In the VRU-ITS-S, the presence of this function shall depend on the VRU equipment type (see ETSI TR 103 300-1 [i.1]) and shall be provided to the VBS with its initial configuration (see VRU profile management function in clause 6.5.12 of ETSI TS 103 300-2 [1]). For example, VRUs of type VRU-RX will not include the VAM transmission management function.



## VAM Encoding

The VAM encoding function encodes the Data Elements provided by the VAM transmission management function complying with the VAM specification.

The VAM encoding function shall trigger the VAM transmission to the Networking and Transport layer via the configured port indicating the selected communication profile.

The VAM encoding function is available only if the VAM transmission management function is available.

## 5.3 Interfaces of the VRU basic service

### 5.3.1 VRU basic service interfaces in the facilities layer (IF.OFa)

The interactions between the VRU basic service and other facilities layer entities in the ITS-S architecture are used to obtain information for the generation of the VAM. The interfaces for these interactions are described in Table 2.

**Table 2: VRU basic service interfaces (IF.OFa)**

Interfaced functionality	Parameters
PoTi	Information of the positioning and timing are sent to the VRU basic service, i.e. the position of the ITS-S and time information specified in ETSI EN 302 890-2 [4]. Further details are described in clause 6.5.10.3 of ETSI TS 103 300-2 [1].
CA Basic service	In case of a motorcycle, the VRU basic service needs to inform the Cooperative Awareness basic service that the vehicle is a VRU from VRU profile 3 and trigger the dedicated container when transmitting CAMs. It also needs to provide associated DEs to put in the VRU special container, e.g. type of profile, roll angle, path prediction, etc.
Congestion Control	Information to optimize the use of the available channel are sent to the VRU basic service, e.g. <i>T_GenVam_Dcc</i> in the case of the ITS-G5 access layer. Further details are described in clause 6.5.10.5 of ETSI TS 103 300-2 [1].
HMI support	The interactions between the VRU basic service and the HMI support function of the facilities layer are necessary for the exchange of information (parameters, data elements) to be used for the management of the VRU awareness service and the provisioning of data elements in VAMs. The HMI support function can be implemented to select any proper data in the candidate list such as VRU profile. The HMI support function can forward input data from the touchscreen or button in the device of VRU to VRU basic service. Awareness advices and alert may be provided to VRU via its HMI according to its personalized characteristics. Further details are described in clause 6.5.7 of ETSI TS 103 300-2 [1].
LDM	LDM/VAM data are exchanged via the interface between LDM and the VRU basic service. Further details are described in clause 6.5.10.2 of ETSI TS 103 300-2 [1].
Device Data Provider (DDP)	The DDP provides the device status information obtained from its local perception entities (see ETSI TS 103 300-2 [1]) to the VRU basic service.
Other application support facilities	Information to trigger the transmission of messages is sent to the VRU basic service. The VRU basic service forwards received messages to the relevant applications. Further details are described in clause 6.5.10.4 of ETSI TS 103 300-2 [1].

### 5.3.2 Interface to the ITS applications (IF.FA)

An ITS application is a function of the ITS application layer that implements the application logic of one or more use cases.

The VRU basic service provides the interfaces to the ITS-S applications for the VAM protocol operation of the originator ITS-S and receiver ITS-S.

**NOTE:** The interface to the ITS application layer may be implemented as an API with data exchanged between the VRU basic service and ITS applications via this API. In another possible implementation, the interface to the application layer may be implemented as FA-SAP. Specifications of the FA-SAP and the corresponding protocols and APIs are out of scope of the present document.

According to designers' implementation, the VBS may need to directly exchange data, parameters, states evolutions and event detection signals with an ITS application.

When the SPAT/MAP basic service is locally present, the traffic light states (phase and timing) should be communicated to the application which is using it for predicting the VRU motion dynamic according to the VRU related traffic light phase and timing and the likelihood that the VRU behaves in respect of the traffic light state. The result of this application analysis, for example as the path prediction, may then be provided to the VBS for inclusion in the VAM.

The VRU cluster status and the path prediction can be the cases when the VBS may need to exchange data, parameters with ITS applications directly. The VBS may need to exchange data with ITS applications via LDM to detect whether the VRU is located in a low-risk geographical area, which impacts the sending of VAM.

As the specification of these interactions, via a possible API, between the VBS and an ITS application is implementation dependent, it is out of the scope of the present document.

### 5.3.3 Interface to the ITS-S networking and transport layer (IF.NF)

#### 5.3.3.1 General requirements

The VRU basic service exchanges information with ITS networking & transport layer via the interface NF in Figure 2. A specification of the interface IF.NF as NF-SAP in Figure 1 is provided in ETSI TS 102 723-11 [i.5].

At the originating ITS-S, the VRU basic service shall provide the VAM embedded in a Facilities Layer-Service Data Unit (FL-SDU) together with Protocol Control Information (PCI) according to ETSI TS 103 836-5-1 [3] to the ITS networking & transport layer. At the receiving ITS-S, the ITS networking & transport layer will pass the received VAM to the VRU basic service, when available.

The minimum data set that shall be passed between VRU basic service and ITS networking & transport layer for the originating and receiving ITS-S is specified in Table 3.

**Table 3: Data passed between VRU basic service and the ITS Networking & Transport layer**

Category	Data	Data requirement	Mandatory/Optional
Data passed from the VRU basic service to the ITS networking & transport layer	VAM	{ <i>vam</i> } as specified in annex A	Mandatory
	PCI	Depending on the protocol stack applied in the networking and transport layer as specified in clause 5.3.3.2 or 5.3.3.3	Mandatory
Data passed from the ITS networking & transport layer to the VRU basic service	Received VAM	{ <i>vam</i> } as specified in annex A	Mandatory

The interface between the VRU basic service and the Networking & Transport Layer relies on the services of the GeoNetworking/BTP stack as specified in clause 5.3.3.2 or to the IPv6 stack and the combined IPv6/GeoNetworking stack as specified in clause 5.3.3.3.

#### 5.3.3.2 Interface to the GeoNetworking/BTP stack

The VRU basic service may rely on services provided by the GeoNetworking/BTP stack to disseminate a VAM to a geographic destination area.

PCI being passed from VRU basic service to the GeoNetworking/BTP stack shall comply with Table 3 and Table 4.

**Table 4: Data passed from VRU basic service to GeoNetworking/BTP at the originating ITS-S**

Category	Data	Requirement	Mandatory/Conditional
Data passed from the VRU basic service to GeoNetworking/BTP	BTP type	BTP header type B (ETSI TS 103 836-5-1 [3], clause 7.2.2)	Conditional The data shall be passed if the value is not provided by the ITS-S configuration, e.g. defined in a Management Information Base (MIB) or if the value is different from the default value as set in the MIB.
	Destination port	As specified in ETSI TS 103 836-5-1 [3] (see note)	Conditional The data shall be passed if the value is not provided by the ITS-S configuration, e.g. defined in a Management Information Base (MIB) or if the value is different from the default value as set in the MIB.
	Destination port info	As specified in ETSI TS 103 836-5-1 [3]	Conditional The data shall be passed if the value is not provided by the ITS-S configuration, e.g. defined in a Management Information Base (MIB) or if the value is different from the default value as set in the MIB.
	GN Packet transport type	GeoNetworking SHB	Conditional The data shall be passed if the value is not provided by the ITS-S configuration, e.g. defined in a Management Information Base (MIB) or if the value is different from the default value as set in the MIB.
	GN communication profile	Unspecified, ITS-G5 or LTE-V2X	Conditional The data shall be passed if the value is not provided by the ITS-S configuration, e.g. defined in a Management Information Base (MIB) or if the value is different from the default value as set in the MIB.
	GN security profile	SECURED or UNSECURED	Conditional The data shall be passed if the value is not provided by the ITS-S configuration, e.g. defined in a Management Information Base (MIB) or if the value is different from the default value as set in the MIB.
	GN Traffic class	Same GN Traffic class value as for the CAM	Mandatory.
	GN Maximum packet lifetime	Shall not exceed 1 000 ms	Mandatory.
	Length	Length of the VAM	Mandatory.
NOTE: When a global registration authority for ITS application ISO EN 17419 [i.7] is operational, the BTP destination port registered with this authority should be used.			

### 5.3.3.3 Interface to the IPv6 stack and the combined IPv6/GeoNetworking stack

A VAM may use the IPv6 stack or the combined IPv6/GeoNetworking stack for VAM dissemination as specified in ETSI TS 103 836-3 [i.3].

NOTE: When the VAM dissemination makes use of the combined IPv6/GeoNetworking stack, the interface between the VRU basic service and the combined IPv6/GeoNetworking stack may be identical to the interface between the VRU basic service and IPv6 stack. The transmission of VAM over the IPv6 stack is out of scope of the present document.

### 5.3.4 Interface to the ITS-S management entity (IF.MF)

The VRU basic service may exchange primitives with Management entity of the ITS-S via the MF-SAP interface depicted in Figure 1. The VRU basic service gets information for congestion control from the management entity.

The VRU basic service shall be able to receive unsolicited notifications from the ITS-S management entity when the VRU role changes from VRU (e.g. pedestrian crossing a road) to not VRU (e.g. passenger in a bus) and vice-versa.

NOTE 1: A specification of the MF-SAP and a list of primitives exchanged with the management layer are provided in ETSI TS 102 723-5 [i.6].

NOTE 2: Specifications of the MF-SAP and the corresponding protocol are out of scope of the present document.

NOTE 3: The VRU basic service receives communication profile parameters from the network management function located in the Management entity for the selection of the network and its associated communication profile to be used for the VAM dissemination.

### 5.3.5 Interface to the ITS-S security entity (IF.SF)

The VRU basic service may exchange primitives with the Security entity of the ITS-S via the SF-SAP interface in Figure 1 using the SF interface (IF.SF) provided by the Security entity in Figure 2. The SF-SAP interface is provisioned in ETSI TS 103 898 [i.11] but not yet specified as of the current version of the present document. Accordingly, this clause refers informatively to ETSI TS 102 723-8 [i.8] as it specifies a functionality equivalent to the functionality defined in this clause, even though targeted at the SN-SAP interface.

The VBS shall subscribe to the identity change service provided by the security entity as specified in ETSI TS 102 731 [12]. A model for subscribing to this service is provided by the SN\_IDCHANGE\_SUBSCRIBE primitives in ETSI TS 102 723-8 [i.8].

When the VBS is notified by the security entity of a pending identifier change, it shall temporarily stop generating VAMs. Once the VBS receives notification that the identifier change has been committed, it shall restart generating and sending VAMs. The VAMs sent after the COMMIT shall have different StationId and (if present) ClusterId values than the VAMs sent before the COMMIT. A model for being notified of and committing to identifier changes is provided by the SN-SAP primitive SN\_IDCHANGE\_EVENT with command types PREPARE and COMMIT as specified in ETSI TS 102 723-8 [i.8].

The VBS may determine through mechanisms out of the scope of the present document that its VRU is in an elevated-hazard situation and may in this situation inhibit identifier change. Once the elevated hazard situation is over the VBS shall permit identifier change again. The VBS should not prolong identifier locking unnecessarily. A model for locking and unlocking identifier changes is provided by the SN-SAP primitives SN\_ID\_LOCK and SN\_ID\_UNLOCK as specified in ETSI TS 102 723-8 [i.8].

NOTE: Specifications of the SF-SAP and the corresponding protocol are out of the scope of the present document.

## 5.4 VRU cluster specification

### 5.4.1 VRU clustering functional overview

The clustering operation as part of the VRU basic service is intended to optimize the resource usage in the ITS system. These resources are mainly spectrum resources and processing resources.

A huge number of VRUs in a certain area (pedestrian crossing in urban environment, large squares in urban environment, special events like large pedestrian gatherings) would lead to a significant number of individual messages sent out by the VRU ITS-S and thus a significant need for spectrum resources. Additionally, all these messages would need to be processed by the receiving ITS-S, potentially including overhead for security operations.

In order to reduce this resource usage, the present document specifies clustering functionality. A VRU cluster is a group of VRUs with a homogeneous behaviour (see ETSI TS 103 300-2 [1]), where VAMs related to the VRU cluster provide information about the entire cluster. Within a VRU cluster, VRU devices take the role of either leader (one per cluster) or member. A leader device sends VAMs containing cluster information and/or cluster operations. Member devices send VAMs containing cluster operation container to join/leave the VRU cluster. Member devices do not send VAMs containing cluster information container at any time.

A cluster may contain VRU devices of multiple profiles. A cluster is referred to as "homogeneous" if it contains devices of only one profile, and "heterogeneous" if it contains VRU devices of more than one profile (e.g. a mixed group of pedestrians and bicyclists). The VAM *ClusterInformationContainer* contains a field allowing the cluster container to indicate which VRU profiles are present in the cluster. Indicating heterogeneous clusters is important since it provides useful information about trajectory and behaviours prediction when the cluster is broken up.

#### **The support of the clustering function is optional in the VBS for all VRU profiles.**

The decision to support the clustering or not is implementation dependent for all the VRU profiles. When the conditions are satisfied (see clause 5.4.2.4), the support of clustering is recommended for VRU profile 1. An implementation that supports clustering may also allow the device owner to activate it or not by configuration. This configuration is also implementation dependent. If the clustering function is supported and activated in the VRU device, and only in this case, the VRU ITS-S shall comply with the requirements specified in clause 5.4.2 and clause 7 of the present document, and define the parameters specified in clause 5.4.3. As a consequence, cluster parameters are grouped in two specific and conditional mandatory containers in the present document.

The basic operations to be performed as part of the VRU cluster management in the VRU basic service are:

- **Cluster identification:** intra-cluster identification by cluster participants in Ad-Hoc mode.
- **Cluster creation:** creation of a cluster of VRUs including VRU devices located nearby and with similar intended directions and speeds. The details of the cluster creation operation are given in clause 5.4.2.2.
- **Cluster breaking up:** disbanding of the cluster when it no longer participates in the safety related traffic or the cardinality drops below a given threshold.
- **Cluster joining and leaving:** intro-cluster operation, adding or deleting an individual member to an existing cluster.
- **Cluster extension or shrinking:** operation to increase or decrease the size (area or cardinality).

Any VRU device shall lead a maximum of one cluster. Accordingly, a cluster leader shall break up its cluster before starting to join another cluster. This requirement also applies to combined VRUs as defined in ETSI TS 103 300-2 [1] joining a different cluster (e.g. while passing a pedestrian crossing). The combined VRU may then be re-created after leaving the heterogeneous cluster as needed. For example, if a bicyclist with a VRU device, currently in a combined cluster with his bicycle which also has a VRU device, detects it could join a larger cluster, then the leader of the combined VRU breaks up the cluster and both devices each join the larger cluster separately. The possibility to include or merge VRU clusters or combined VRUs inside a VRU cluster is left for further study.

The present document specifies a simple in-band VAM signalling for the operation of VRU clustering. Further methods may be optionally defined to establish, maintain and tear up the association between devices (e.g. Bluetooth®, UWB, etc.). They are out of scope of the present document.

## 5.4.2 VRU cluster operation

### 5.4.2.1 VBS clustering states

Depending on its context, the VRU Basic Service (VBS) shall be in one of the cluster states specified in Table 5.

**Table 5: Possible states of the VRU basic service related to cluster operation**

VBS State	Specification	Valid VRU profiles	Valid VRU types	Additional explanation
VRU-IDLE	The device user is not considered as a VRU	ALL	ALL	The VRU role as defined in clause 4.2 is <code>VRU_ROLE_OFF</code> .
VRU-ACTIVE-STANDALONE	VAMs or CAMs (in case of VRU Profile 2) are transmitted with information related to only that VRU	ALL	VRU-St, VRU-Tx	In this state a VRU ITS-S may indicate an intention to join a cluster, or indicate that it has just left a cluster.
VRU-ACTIVE-CLUSTER-LEADER	VAMs are transmitted and include a container with specific data elements related to the cluster	VRU profile 1, VRU profile 2	VRU-St	
VRU-PASSIVE	The VRU device does not transmit VAMs	ALL except VRU profile 3	VRU-St, VRU-Tx	The VRU is member of a cluster or located in a low-risk geographical area defined in clause 3.1 (see FCOM03 in ETSI TS 103 300-2 [1]). In the case the area rules authorize the traffic of motor vehicles, the VBS can also remain in VRU-ACTIVE-STANDALONE VBS state and increase the periodicity of the VAMs.

In all VBS states, the VRU basic service in a VRU device shall remain operational.

### 5.4.2.2 Events triggering a transition between VBS clustering states

In addition to the normal VAM triggering conditions defined in clause 6, the following events shall trigger a VBS state transition related to cluster operation. Parameters that control these events are summarized in clause 8, Table 14 and Table 15.

- **Entering VRU role:** VRU-IDLE

When the VBS in VRU-IDLE determines that the VRU device user has changed its role to `VRU_ROLE_ON` (e.g. by exiting a bus), it shall start the transmission of VAMs, as defined in clause 4.2. A VBS executing this transition shall not belong to any cluster.

- Next state: VRU-ACTIVE-STANDALONE

- **Leaving VRU role:** VRU-ACTIVE-STANDALONE

When the VBS in VRU-ACTIVE-STANDALONE determines that the VRU device user has changed its role to `VRU_ROLE_OFF` (e.g. by entering a bus or a passenger car), it shall stop the transmission of VAMs, as defined in clause 4.2. A VBS executing this transition shall not belong to any cluster.

- Next state: VRU-IDLE

- **Creating a VRU cluster:** Initial state: VRU-ACTIVE STANDALONE

When the VBS in VRU-ACTIVE-STANDALONE determines that it can form a cluster based on the received VAMs from other VRUs (see conditions in clause 5.4.2.4), it shall take the following actions:

- 1) Generate a random cluster identifier. The identifier shall be locally unique, i.e. it shall be different from any cluster identifier in a VAM received by the VBS in the last *timeClusterUniquenessThreshold* time, and it shall be non-zero. The identifier does not need to be globally unique, as a cluster is a local entity and can be expected to live for a short time frame.

- 2) Determine an initial cluster dimension to delimit the cluster bounding box. To avoid false positives, the initial bounding box shall be set to include only the cluster leader VRU.
- 3) Set the size of the cluster to *minClusterSize* and the VRU cluster profiles field to its own VRU profile.
- 4) Transition to the next state, i.e. start transmitting cluster VAMs.

NOTE 1: The random selection of the cluster ID protects against the case where two cluster leaders, which select an ID simultaneously, select the same identifier.

NOTE 2: Cluster creation is different from cluster joining as defined in clause 5.4.2.4 in that a VRU device joining a cluster gives an indication that it will join the cluster beforehand, while a VRU device creating a cluster simply switches from sending individual VAMs to sending cluster VAMs.

- Next state: VRU-ACTIVE-CLUSTER-LEADER

- **Breaking up a VRU cluster:** Initial state: VRU-ACTIVE-CLUSTER-LEADER

When the VBS in VRU-ACTIVE-CLUSTER-LEADER determines that it should break up the cluster, it shall include in the cluster VAMs a VRU cluster operation field indicating that it will disband the cluster with the VRU cluster's identifier and a reason to break up the VRU cluster (see clause 7.3.5 for the list of possible reasons).

It shall then shortly stop sending cluster VAMs. This indication is transmitted for *timeClusterBreakupWarning* in consecutive VAMs.

All VRU devices in the cluster shall resume sending individual VAMs, i.e. they transition to state VRU-ACTIVE-STANDALONE. Other VRUs may then attempt to form new clusters with themselves as leaders as specified above.

- Next state: VRU-ACTIVE-STANDALONE

- **Joining a VRU cluster:** Initial state: VRU-ACTIVE-STANDALONE

When a VRU device receives cluster VAMs from a cluster leader, the VBS in VRU-ACTIVE-STANDALONE shall analyse the received cluster VAMs and decide whether it should join the cluster or not (see conditions in clause 5.4.2.4). Joining a cluster is an optional operation.

Before joining the cluster, the VRU shall include in its individual VAMs an indication that it is joining the identified cluster along with an indication of the time at which it intends to stop sending individual VAMs. It shall send these indications for a time *timeClusterJoinNotification*.

Once the VRU has sent the appropriate number of notifications, it joins the cluster, i.e. it stops transmission and starts monitoring the cluster VAMs from the cluster leader.

**Cancelled-join handling:** If the VBS determines that it will not join the cluster after having started the joining operation (for example because it receives a VAM with the maximal cluster size (cardinality) *maxClusterSize* exceeded), it stops including the cluster join notification in its individual VAMs and includes the cluster leave notification for a time *timeClusterLeaveNotification*. This allows the cluster leader to track the size of its cluster.

**Failed-join handling:** If after ceasing to send individual VAMs the VBS determines that the cluster leader has not updated the cluster state to contain that new member (e.g. the device is not inside the bounding box information provided in the received cluster VAM from the cluster leader, or the size is not consistent with observed cluster join and leave notifications), or the cluster it intended to join does not exist anymore, the VBS shall leave the cluster, i.e. it shall start transmitting individual VAMs again and remain in VRU-ACTIVE-STANDALONE state. The VBS shall take this action if the first cluster VAM received after *timeClusterJoinSuccess* passes does not account for the ego VBS.

When the ego VBS transmits individual VAMs after a cancelled-join or a failed-join, it shall:

- a) use the same station ID it used before the cancelled-join or failed-join;
- b) include the cluster leave notification for a time *timeClusterLeaveNotification*.

A VRU ITS-S that experiences a "failed join" of this type may make further attempts to join the cluster. Each attempt shall follow the process defined in this transition case.

A VRU device may determine that it is within a cluster bounding box indicated by a message other than a VAM (for example a CPM). In that case, it shall follow the cluster join process described here, but shall provide the special value "0" as identifier of the cluster it joins.

- Next state: VRU-PASSIVE

- **Leaving a VRU cluster:** Initial state: VRU-PASSIVE

When a VRU in a cluster receives VAMs from the VRU cluster leader, the VBS shall analyse the received VAMs and decide whether it should leave the cluster or not (see clause 5.4.2.4). Leaving the cluster consists of resuming to send individual VAMs.

When the VRU ITS-S leaves the cluster, the VAMs that it sends after state VRU-PASSIVE ends, shall indicate that it is leaving the identified cluster with a reason why it leaves the identified cluster (see clause 7.3.5 for the list of reasons). It shall include this indication for time *timeClusterLeaveNotification*.

A VRU is always allowed to leave a cluster for any reason, including its own decision or any safety risk identified.

After a VRU leaves a cluster and starts sending individual VAMs, it should use different identifiers (including Station ID in the VAM and pseudonym certificate) from the ones it used in individual VAMs sent before it joined the cluster. **Exception:** if the VRU experiences a cancelled-join or a failed-join as specified above (in "Joining a VRU cluster" transition), it should use the Station ID and other identifiers that it was using before the failed join to allow better tracking by the cluster leader of the state of the cluster for a *numClusterVAMRepeat* number of VAMs, and resume the pseudonymization of its Station ID afterwards.

A VRU device that is in VRU-PASSIVE state and within a cluster indicated by a message other than a VAM (for example a CPM) may decide to resume sending the VAM because it has determined it was within the cluster indicated by the other message, but is now going to leave or has left that cluster bounding box. In that case, it shall follow the cluster leave process described here, indicating the special cluster identifier value "0".

- Next state: VRU-ACTIVE-STANDALONE

- **Determining VRU cluster leader lost:** In some cases, the VRU cluster leader may lose communication connection or fail as a node. In this case, the VBS of the cluster leader cannot send VAMs any more on behalf of the cluster. When a VBS in VRU-PASSIVE state because of clustering determines that it did not receive VAMs from the VRU cluster leader for a time *timeClusterContinuity*, it shall assume that the VRU cluster leader is lost and shall leave the cluster as specified previously.

- Next state: VRU-ACTIVE-STANDALONE

### 5.4.2.3 Events not triggering a transition between VBS clustering states

The following actions do not trigger a state transition but shall cause an update of information.

- **Extending or shrinking a VRU cluster:** State: VRU-ACTIVE-CLUSTER-LEADER

A VAM indicating that a VRU is joining the cluster allows the VRU cluster leader to determine whether the cluster is homogeneous or heterogeneous, its profile, bounding box, velocity and reference position, etc. The cluster data elements in the cluster VAM shall be updated by the VRU cluster leader to include the new VRU. The same applies when a VRU leaves the cluster.

- **Changing a VRU cluster ID:** State: VRU-ACTIVE-CLUSTER-LEADER, VRU-PASSIVE

A cluster leader may change the cluster ID at any time and for any reason.

The cluster leader shall include in its VAMs an indication that the cluster ID is going to change for time *timeClusterIdChangeNotification* before implementing the change. The notification indicates the time at which the change will happen. The cluster leader shall transmit a cluster VAM with the new cluster ID as soon as possible after the ID change. VRU devices in the cluster shall observe at that time whether there is a cluster with a new ID that has similar bounding boxes and dynamic properties to the previous cluster. If there is such a cluster, the VRU devices shall update their internal record of the cluster ID to the newly observed cluster ID.



If there is no such cluster, the VRU devices shall execute the leave process with respect to the old cluster. VRU devices that leave a cluster that has recently changed ID may use either the old or the new cluster ID in their leave indication for time *timeClusterIdPersist*. After that time, they shall only use the new cluster ID.

If the VBS of a cluster leader receives a VAM from another VRU with the same identifier as its own, it shall immediately trigger a change of the cluster ID complying with the process described in the previous paragraph.

NOTE: The transmission of intent to change cluster ID does not significantly impact privacy. This is because an eavesdropper who is attempting to track a cluster and is listening to the cluster VAMs at the time of an ID change will be able to determine continuity of the cluster anyway, by "joining the dots" of its trajectory through the ID change using the dynamic information. ID change is intended mainly to protect against an eavesdropper who is not continually listening, but instead has the capability to listen only in discrete, isolated locations. For this eavesdropper model, including a "change prepare" notification for a short time does not significantly increase the likelihood that the eavesdropper will be able to track the cluster through the ID change. The new cluster ID is not provided in the notification, only the time when the ID is intended to change.

#### 5.4.2.4 Conditions for clustering operations

**Conditions to determine whether to create a cluster:** a VRU device with a VBS in VRU-ACTIVE-STANDALONE can create a cluster if all these conditions are met:

- It has sufficient processing power (indicated in the VRU configuration received from the VRU profile management function).
- It has been configured with VRU equipment type VRU-St (as defined in clause 4.4 of ETSI TR 103 300-1 [i.1]).
- It is receiving VAMs from *numCreateCluster* different VRUs not further away than *maxClusterDistance*.
- It has failed to identify a cluster it could join.

Another possible condition is that the VRU-ITS-S has received an indication from a neighbouring V-ITS-S or R-ITS-S that a cluster should be created. This is left for further study.

**Conditions to determine whether to join or leave a cluster in normal conditions:** a VRU device whose VBS is in VRU-ACTIVE-STANDALONE state shall determine whether it can join or should leave a cluster by comparing its measured position and kinematic state with the position and kinematic state indicated in the VAM of the VRU cluster leader. Joining a cluster is an optional operation.

- If the compared information fulfils certain conditions, i.e. the cluster has not reached its maximal size (cardinality) *maxClusterSize*, the VRU is within the VRU cluster bounding box or at a certain distance *maxClusterDistance* away from the VRU cluster leader and velocity difference less than *maxClusterVelocityDifference* of own velocity, the VRU device may join the cluster.
- After joining the cluster, when the compared information does not fulfil the previous conditions any longer, the VRU device shall leave the cluster. If changing its role to non-VRU (e.g. by entering a bus or a passenger car), the VRU device shall also follow the leaving process described in clause 5.4.2.2.
- If the VRU device receives VAMs from two different clusters that have the same cluster ID (e.g. due to hidden node situation), it shall not join any of the two clusters.
- In the case the VBS, after leaving a VRU cluster, determines that it has entered a low-risk geographical area as defined in clause 3.1 (e.g. through the reception of a MAPEM), according to requirement FCOM03 in ETSI TS 103 300-2 [1], it shall transition to the VRU-PASSIVE state (see clause 6).
- The VBS shall indicate in the VAM the reason why it leaves a cluster, as defined in clause 7.3.5.

In some cases, merging VRU clusters can further reduce VRU messaging in the network. For example, moving VRU clusters on a sidewalk with similar coherent cluster velocity profiles may have fully or partially overlapped bounding boxes (see clause 5.4.3) and so may merge to form one larger cluster. This shall be done as specified in clause 5.4.1, i.e. the second cluster leader shall break up its cluster, enter VRU-ACTIVE-STANDALONE state and join the new cluster as an individual VRU. All devices that were part of the cluster led by the second cluster leader become individual VRUs (i.e. enter VRU-ACTIVE-STANDALONE state) and may choose individually to join the cluster led by the first cluster leader.

#### 5.4.2.5 State diagram related to VRU cluster operation

Figure 3 illustrates the state diagram related to VRU cluster operation.

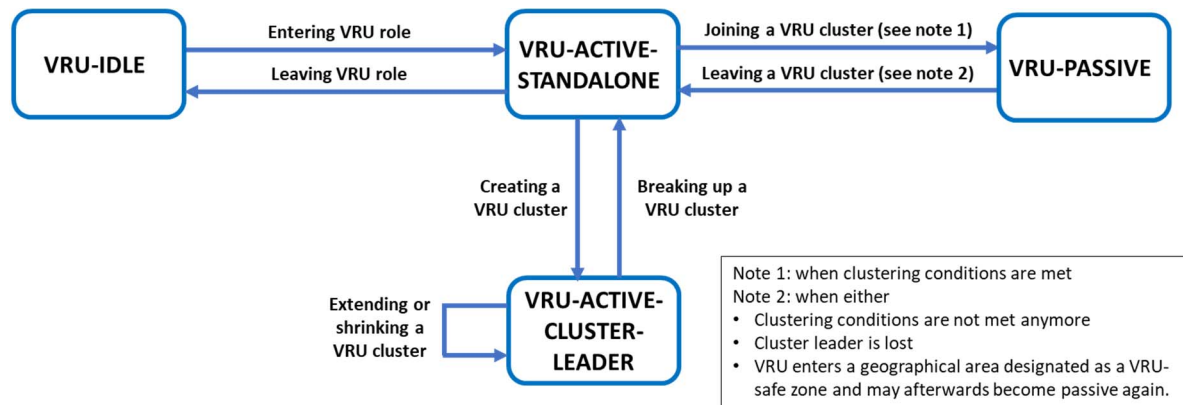

Figure 3: VBS state diagram related to VRU cluster operation

#### 5.4.2.6 Application to the specific case of a combined VRU

A combined VRU groups the device of at least one VRU from VRU Profile 1 (e.g. a pedestrian) and the device located in a VRU vehicle from VRU Profile 2 or VRU Profile 3 (e.g. motorcycle, bicycle, wheel chair, mounted animal), as described in ETSI TS 103 300-2 [1]. As a pre-requisite to the creation of a combined VRU, the VBS in the VRU vehicle device is activated and has its role set to VRU. In the case when only one element of the couple {VRU, VRU vehicle} is equipped with a VRU device, it shall behave as a regular VRU. The combined clustering function is an optional function in the VBS, in the same manner as the clustering (see clause 5.4.1).

When the combined clustering function is used, the operation of a combined VRU shall follow the same rules as the operation of a VRU cluster:

- When the VBS in VRU-ACTIVE-STANDALONE of the VRU vehicle ITS-S (see clause 4.4 in ETSI TS 103 300-2 [1]) determines that it can form a combined VRU, it shall send a VAM indicating that it will lead the cluster by including cluster information (if it is a profile 2 device) or a CAM containing cluster information in the VRU extension (if it is a profile 3 device).
- If the VRU vehicle ITS-S is a profile 3 VRU, then when the VBS in the P-ITS-S of the VRU determines that the cluster joining conditions are met, it shall send a VAM indicating that it joins the combined cluster using the standard cluster join process. In the case of a combined VRU, the maximal bounding box of a VRU cluster is reduced to *maxCombinedClusterDistance*.
- If the VRU vehicle ITS-S is a profile 2 VRU, it shall continue to send cluster VAMs for at least *timeCombinedVruClusterOpportunity*. If no P-ITS-S has in that time indicated that it will join the cluster, the VRU vehicle ITS-S shall stop sending cluster VAMs (the P-ITS-S does not need to complete the join in that time so long as it has started to include the join indication in its VAMs). If the VRU vehicle ITS-S has stopped sending cluster VAMs, the P-ITS-S may create a combined cluster, i.e. it may send cluster VAMs with cluster cardinality 1, and shall send the cluster VAM for a time at least equal to *timeCombinedVruClusterOpportunity*. While the P-ITS-S is sending cluster VAMs, the VRU vehicle ITS-S may initiate the process of joining the cluster.

NOTE: This process allows flexibility in which ITS-S is the cluster leader because in practice either the P-ITS-S or the profile 2 VRU vehicle ITS-S may be better equipped to act as the leader. The present document does not specify how either ITS-S determines whether or not to join a cluster; the process may, for example, involve user intervention on either or both ITS-S or pre-configured setting. Future versions of the present document may provide more support for automated cluster leader decisions, for example by including the data structures for cluster leaders to make statements about their capabilities that could be inputs to those decisions.

- When the VBS in the cluster member VRU device determines that the clustering conditions are not met anymore (separation from the cluster leader VRU device), it shall leave the cluster using the cluster leave process specified in clause 5.4.2.2.

Figure 4 illustrates an example of the instantiation of the state diagram presented in Figure 3 for a combined VRU made of a person holding a VRU-enabled personal device and a VRU-enabled bicycle.

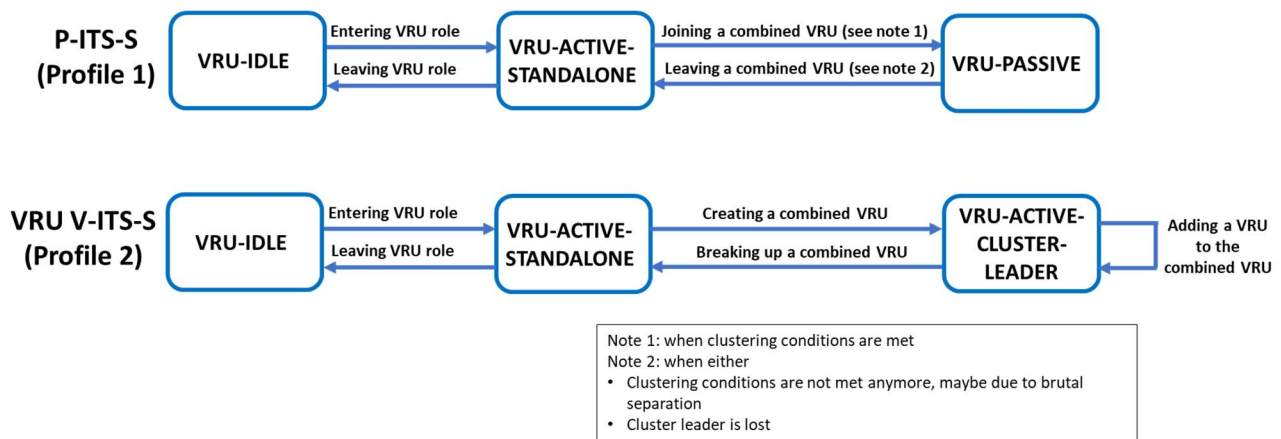

Figure 4: Example of a combined VRU

### 5.4.3 Cluster information parameters

A VRU cluster is considered as a single entity in the overall VRU communication system. If a cluster exists, cluster members shall not transmit VAMs, and only the cluster leader shall transmit cluster VAMs that describe the entire cluster. The parameters included in a cluster VAM shall be as in Table 6.

Table 6: Cluster VAM parameters

Cluster identifier	M	
Bounding box of the VRU cluster (shape)	M	<ul style="list-style-type: none"> <li>• Circle (the centre of a circle, radius)</li> <li>• Rectangle (the reference point, length, width)</li> <li>• Polygon (list of positions which indicate polygon points)</li> </ul>
Cardinality size of the VRU cluster	M	<ul style="list-style-type: none"> <li>• Number of cluster members in the cluster + 1 (the cluster leader)</li> <li>• Initial value shall be "1"</li> </ul>
Profiles of VRUs within the VRU cluster	O	
NOTE:	"M" stands for "mandatory" which means that the data element shall be always included in the cluster VAM message. "O" stands for "optional" which means that the data element can be included in the cluster VAM message.	

## 6 VAM dissemination

### 6.1 VAM transmission method

Point-to-multipoint communication shall be used for transmitting VAMs, as specified in ETSI TS 103 300-2 [1].

NOTE: Point-to-multipoint communication is specified in ETSI TS 103 836-4-1 [i.2] and ETSI TS 103 836-3 [i.3].

## 6.2 Frequency/Periodicity range of VAMs

NOTE: The values of the parameters in clause 6.2 are provided in clause 8, Table 16.

A VAM generation event results in the generation of one VAM.

The minimum time elapsed between the start of consecutive VAM generation events shall be equal to or larger than  $T\_GenVam$ .  $T\_GenVam$  is limited to  $T\_GenVamMin \leq T\_GenVam \leq T\_GenVamMax$ , where  $T\_GenVamMin$  and  $T\_GenVamMax$  are specified in Table 16 (clause 8). When a cluster VAM is transmitted, the  $T\_GenVam$  could be smaller than that of individual VAM. The minimum time elapsed between two consecutive low frequency containers (see clause 7.3.4) is captured as 2 000 ms. The low frequency container carries configuration attributes and they normally vary slower than other VAM attributes. This selection may also contribute to bandwidth efficiency and power saving.

The conditions for triggering the VAM generation shall be checked repeatedly every  $T\_CheckVamGen$ .  $T\_CheckVamGen$  shall be equal to or less than  $T\_GenVamMin$ .

The low frequency container of the VAM is included periodically or when the VRU cluster operation container is present (see clause 7.3.2). It shall be included in the first VAM generation since the vulnerable user basic service activation. After that, the low frequency container of VAM shall be included every time the time elapsed since the generation of the last VAM with the low frequency container is equal to or greater than 2 000 ms.

In case of ITS-G5,  $T\_GenVam$  shall be managed according to the channel usage requirements of Decentralized Congestion Control (DCC). The parameter  $T\_GenVam$  shall be provided by the VBS management entity in the unit of milliseconds. If the management entity provides this parameter with a value above  $T\_GenVamMax$ ,  $T\_GenVam$  shall be set to  $T\_GenVamMax$  and if the value is below  $T\_GenVamMin$  or if this parameter is not provided, the  $T\_GenVam$  shall be set to  $T\_GenVamMin$ . The parameter  $T\_GenVam$  represents the currently valid lower limit for the time elapsed between consecutive VAM generation events.

In case of LTE-V2X PC5,  $T\_GenVam$  shall be managed in accordance to the congestion control mechanism defined by the access layer specified in ETSI TS 103 574 [11].

## 6.3 Transmitting VAMs

VRU ITS-S in VRU-ACTIVE-STANDALONE state shall send "individual VAMs", while VRU ITS-S in VRU-ACTIVE-CLUSTERLEADER VBS state shall transmit "cluster VAMs" on behalf of the VRU cluster. Cluster member VRU ITS-S in VRU-PASSIVE VBS state shall send individual VAMs containing *VruClusterOperationContainer* while leaving the VRU cluster. VRU ITS-S in VRU-ACTIVE-STANDALONE shall send VAM as "individual VAM" containing *VruClusterOperationContainer* while joining the VRU cluster.

## 6.4 Triggering conditions

### 6.4.1 Individual VAM transmission management by VBS at VRU ITS-S

NOTE: The values of the parameters in clause 6.4 are provided in Table 17.

The first time individual VAM shall be generated immediately after VBS activation. The VAM shall also be generated at the earliest time instant for transmission if any of the following conditions are satisfied and the individual VAM transmission does not subject to redundancy mitigation techniques:

- 1) A VRU is in VRU-IDLE VBS state and has entered VRU-ACTIVE-STANDALONE.
- 2) A VRU is in VRU-PASSIVE VBS state; it decides to leave the cluster and enters in VRU-ACTIVE-STANDALONE VBS state.
- 3) A VRU is in VRU-PASSIVE VBS state; it has determined that VRU cluster leader is lost and has decided to enter VRU-ACTIVE-STANDALONE VBS state.

- 4) A VRU is in VRU-ACTIVE-CLUSTER-LEADER VBS state; it has determined breaking up the cluster and has transmitted VRU cluster VAM with disband indication; it has decided to enter VRU-ACTIVE-STANDALONE VBS state.

Consecutive VAM transmissions are contingent upon the conditions described here. Consecutive individual VAM generation events shall occur at an interval equal to or larger than  $T_{GenVam}$ . An individual VAM shall be generated for transmission as part of a generation event if the originating VRU ITS-S is still in VBS VRU-ACTIVE-STANDALONE VBS state, any of the following conditions is satisfied and individual VAM transmission is not subject to redundancy mitigation techniques:

- 1) The time elapsed since the last time the individual VAM was transmitted exceeds  $T_{GenVamMax}$ .
- 2) The Euclidian absolute distance between the current estimated position of the reference point of the VRU and the estimated position of the reference point lastly included in an individual VAM exceeds a pre-defined threshold  $minReferencePointPositionChangeThreshold$ .
- 3) The difference between the current estimated ground speed of the reference point of the VRU and the estimated absolute speed of the reference point of the VRU lastly included in an individual VAM exceeds a pre-defined threshold  $minGroundSpeedChangeThreshold$ .
- 4) The difference between the orientation of the vector of the current estimated ground velocity of the reference point of the VRU and the estimated orientation of the vector of the ground velocity of the reference point of the VRU lastly included in an individual VAM exceeds a pre-defined threshold  $minGroundVelocityOrientationChangeThreshold$ .
- 5) The VRU has determined that there is a difference between the current estimated trajectory interception probability with vehicle(s) or other VRU(s) and the trajectory interception probability with vehicle(s) or other VRU(s) lastly reported in an individual VAM exceeds a predefined threshold  $minTrajectoryInterceptionProbChangeThreshold$ .
- 6) The originating ITS-S is a VRU in VRU-ACTIVE-STANDALONE VBS state and has decided to join a cluster after its previous individual VAM transmission.
- 7) VRU has determined that one or more new vehicles or other VRUs have satisfied the following conditions simultaneously after the lastly transmitted VAM:
  - coming closer than Minimum Safe Lateral Distance (MSLaD) laterally;
  - coming closer than Minimum Safe Longitudinal Distance (MSLoD) longitudinally;
  - coming closer than Minimum Safe Vertical Distance (MSVD) vertically.

## 6.4.2 Cluster VAM transmission management by VBS at VRU ITS-S

The first time VRU cluster VAM shall be generated immediately after VBS activation. The VAM shall also be generated at the earliest time instant for transmission if any of the following conditions are satisfied and the VRU cluster VAM transmission is not subject to redundancy mitigation techniques:

- 1) A VRU in VRU-ACTIVE-STANDALONE VBS State determines to form a VRU cluster.

Consecutive VRU cluster VAM transmissions are contingent upon the conditions described here. Consecutive VRU cluster VAM generation events shall occur at cluster leader at an interval equal to or larger than  $T_{GenVam}$ . A VRU cluster VAM shall be generated for transmission by the cluster leader as part of a generation event if any of the following conditions is satisfied and VRU cluster VAM transmission is not subject to redundancy mitigation techniques:

- 1) The time elapsed since the last time the VRU cluster VAM was transmitted exceeds  $T_{GenVamMax}$ .
- 2) The Euclidian absolute distance between the current estimated position of the reference point of the VRU cluster and the estimated position of the reference point lastly included in a VRU cluster VAM exceeds a pre-defined threshold  $minReferencePointPositionChangeThreshold$ .
- 3) The difference between the current estimated distance from the cluster boundary and the estimated distance based on the last transmitted VAM exceeds a pre-defined threshold  $minClusterDistanceChangeThreshold$ .

- 4) The difference between the current estimated ground speed of the reference point of the VRU cluster and the estimated absolute speed of the reference point lastly included a VRU cluster VAM exceeds a pre-defined threshold *minGroundSpeedChangeThreshold*.
- 5) The difference between the orientation of the vector of the current estimated ground velocity of the reference point of the VRU cluster and the estimated orientation of the vector of the ground velocity of the reference point lastly included in a VRU cluster VAM exceeds a pre-defined threshold *minGroundVelocityOrientationChangeThreshold*.
- 6) The VRU cluster leader has determined that there is difference between the current estimated trajectory interception probability with vehicle(s) or other VRU(s) and the trajectory interception probability with vehicle(s) or other VRU(s) lastly reported in a cluster VAM exceeds a predefined threshold *minTrajectoryInterceptionProbChangeThreshold*.
- 7) VRU cluster type has been changed (e.g. from homogeneous to heterogeneous cluster or vice versa) after previous VAM generation event.
- 8) Cluster leader has determined to break up the cluster after transmission of previous VRU cluster VAM.
- 9) More than a pre-defined number of new VRUs has joined the VRU cluster after transmission of previous VRU cluster VAM.
- 10) More than a pre-defined number of members has left the VRU cluster after transmission of previous VRU cluster VAM.
- 11) VRU in VRU-ACTIVE-CLUSTER-LEADER VBS state has determined that one or more new vehicles or non-member VRUs (e.g. VRU profile 3 - motorcyclist) have satisfied the following conditions simultaneously after the lastly transmitted VAM:
  - coming closer than Minimum Safe Lateral Distance (MSLaD) laterally;
  - coming closer than Minimum Safe Longitudinal Distance (MSLoD) longitudinally;
  - coming closer than Minimum Safe Vertical Distance (MSVD) vertically to the cluster bounding box.

### 6.4.3 VAM Redundancy Mitigation

A balance between frequency of VAM generation at facilities layer and communication overhead at access layer needs to be considered without impacting VRU safety and VRU awareness in the proximity. VAM transmission at a VAM generation event shall be subject to the following redundancy mitigation techniques:

- An originating VRU ITS-S shall skip current individual VAM if all the following conditions are satisfied simultaneously:
  - The time elapsed since the last time VAM was transmitted by originating VRU ITS-S does not exceed *numSkipVamsForRedundancyMitigation* (e.g. 4) times *T\_GenVamMax*.
  - The Euclidian absolute distance between the current estimated position of the reference point and the estimated position of the reference point in the received VAM from a peer ITS-S is less than *minReferencePointPositionChangeThreshold*.
  - The difference between the current estimated speed of the reference point and the estimated absolute speed of the reference point in received VAM from a peer ITS-S is less than *minGroundSpeedChangeThreshold*.
  - The difference between the orientation of the vector of the current estimated ground velocity and the estimated orientation of the vector of the ground velocity of the reference point in the received VAM from a peer ITS-S is less than *minGroundVelocityOrientationChangeThreshold*.
- Or one of the following conditions are satisfied:
  - VRU consults appropriate maps to verify if the VRU is in protected or non-drivable areas such as buildings, etc.

- VRU is in a geographical area designated as a pedestrian only zone (low-risk geographical area). Only VRU profiles 1 and 4 allowed in the area (see Table 5).
- VRU considers itself as a member of a VRU cluster and cluster break up message has not been received from the cluster leader.
- The information about the ego-VRU has been reported by another ITS-S within  $T\_GenVam$ .

## 6.4.4 VAM time requirement

### 6.4.4.1 VAM generation time

Besides the VAM generation frequency, the time required for the VAM generation and the timeliness of the data taken for the message construction are decisive for the applicability of data in the receiving ITS-Ss. In order to ensure proper interpretation of received VAMs, each VAM shall be time-stamped.

NOTE: An acceptable time synchronization between the different ITS-Ss is expected and it is out of scope of the present document.

The time required for a VAM generation shall be less than  $T\_AssembleVAM$ . The time required for a VAM generation refers to the time difference between time at which a VAM generation is triggered and the time at which the VAM is delivered to the networking & transport layer.

### 6.4.4.2 VAM timestamp

The following requirements shall apply:

- The reference timestamp provided in a VAM disseminated by an ITS-S shall correspond to the time at which the reference position provided in *BasicContainer* DF is determined by the originating ITS-S. The format and range of the timestamp is defined in annex A.
- The difference between VAM generation time and reference timestamp shall be less than 32 767 ms as in ETSI TS 103 900 [6] (see note 1).

NOTE 1: This requirement is set to avoid timestamp wrap-around complications.

NOTE 2: The specification of the ITS time precision and synchronization is specified in ETSI EN 302 890-2 [4] and is out of the scope of the present document.

## 6.5 Security constraints

### 6.5.1 Introduction

VAMs that are transmitted over links that do not provide trust services shall be signed using ITS certificates as specified in ETSI TS 103 097 [8]. In particular, VAMs that are transmitted over BTP with the GeoNetworking protocol shall be signed at the GeoNetworking layer.

In general, within the certificate the permissions and privileges are indicated by a pair of identifiers, the Intelligent Transportations Systems Application Identifier (ITS-AID) and the Service Specific Permissions (SSP). The ITS-AID as specified in ETSI TS 102 965 [9] shall indicate the application for which permissions are being granted. The SSP is a field that indicates specific sets of permissions, corresponding to roles and privileges, within the overall permissions indicated by the ITS-AID.

VAMs shall be identified with the ITS-AID specified in ETSI TS 102 965 [9] for VRU Service.

### 6.5.2 Service Specific Permissions (SSP)

The VAM-SSP octet scheme allows the SSP format to accommodate current and future versions of the present document. The octet scheme is constructed of a single octet taking the value 1, indicating version V2.1.2 of the present document.

The SSP shall be a BitmapSsp as specified in ETSI TS 103 097 [8].

NOTE: The use of a BitmapSsp allows for the SSP to be extended in the future without needing to increase the SSP version number.

### 6.5.3 Certificate attachment policy

The baseline behaviour for attaching certificates to a signed individual VAM is to attach the certificate once a second or if a new vehicle has been observed. Specifically, when the VBS generates an individual VAM and requests it to be signed:

- 1) If it is one second or more since a certificate was last attached to a VAM from that sender, a certificate shall be attached to the signed VAM.
- 2) If a new CAM signer has been observed since a certificate was last attached to a VAM from that sender, a certificate shall be attached to the signed VAM. (A "new CAM signer" is a CAM signer using a certificate that has not previously been used to sign a CAM received by the VRU device.)
- 3) Otherwise, a certificate shall not be attached and the SignerIdentifier in the signed VAM shall be of type digest.

The baseline behaviour for attaching certificates to a signed cluster VAM is to attach the certificate twice a second. Specifically, when the VBS generates a cluster VAM and requests it to be signed:

- 1) If it is 500 ms or more since a certificate was last attached to a VAM from that sender, a certificate shall be attached to the signed VAM.
- 2) Otherwise, a certificate shall not be attached and the SignerIdentifier in the signed VAM shall be of type digest.

### 6.5.4 Privacy considerations

The decision whether to participate in sending VAMs creates a trade-off between personal safety, which is enhanced by the VAM, and privacy, which is reduced by the VAM. From the privacy perspective, sending the VAM creates the risk that if an eavesdropper has an interest in tracking an individual person who is a VRU, the eavesdropper can record VAMs and use those VAMs (and associated data) to determine the exact or approximate path of the target individual.

The present document contains a number of mechanisms to reduce the privacy risks associated with sending VAMs, and in particular the privacy risk against an eavesdropper who records VAMs in different locations and attempts to determine which VAMs have come from the same VRU device. The present document does not have a goal to protect privacy against an eavesdropper who physically follows the individual VRU, as this eavesdropper will always be able to track the individual with or without the VAM.

The mechanisms to improve privacy in the present document are summarized below:

- Clause 5.3.5 of the present document provides a means to synchronize changes of identifiers that are inserted into packets by different entities within the ITS-S, where in this context "identifier" means "values that are unique or locally unique to a particular sender and persistent". This functionality avoids the possibility that (for example) the pseudonym certificate changes but the sending MAC address remains the same, allowing two messages with different certificate to be associated with each other because of the continuity of the MAC address. This provides privacy against an eavesdropper unless that eavesdropper is listening at the exact moment that the identifiers are changed:
  - As a specific instance of identifier change synchronization, clause 7.2 of the present document requires that that *StationId* and the pseudonym are changed at the same time, as enabled by the mechanism of clause 5.3.5.



- The clustering process provides a mechanism for individual VRUs to stop being individually traceable while getting the benefits of the safety enhancements of the VAM, as devices within a cluster do not transmit. In particular, clause 5.4.2.2 of the present document addresses identifier management for VRU devices leaving a cluster. If a VRU device follows the recommendations of this clause, then if it has been in a cluster for long enough to have meaningfully skipped sending some VAMs, it will change its identifiers on leaving the cluster. This provides privacy against an eavesdropper even if the eavesdropper overheard both the join and the leave activities, as the join and the leave indications cannot be correlated via the message contents. The exact statistical improvement in the privacy of the VRU depends on factors such as cluster size and how dynamic the cluster membership is.
- For potentially-unique but unchangeable properties of the VRU, such as dimensions and type, the present document provides the ability for the VRU device not to include those properties in the VAM. Additionally, the VAM does not contain the exact dimensions of the VRU (which would have a high probability of being unique) but instead uses the much coarser *VruSizeClass* type to indicate dimensions. See clause 7.3.4 for more information.
- Other potentially privacy-reducing fields such as *vruDeviceUsage* can be set to indicate that the relevant information is not being provided.

Privacy risks that persist even after these mechanisms are used include the following:

- The VRU sending device may have physical RF characteristics that are unique and persistent and can be measured by the eavesdropper, allowing the device to be identified even if the identifiers in the data or headers are changed.
- The VAM may contain information that is locally unique to the sender and cannot be changed, e.g. dynamic characteristics which can be extracted by analysis of a series of messages, or some combination of properties (such as size class and type) that are not unique on their own but are unique in combination. As discussed in the previous bulleted list in this clause, the VAM sender has the option to omit some of the information of this type, but there will be a trade-off between privacy on the one hand, and quality of information obtained by VAM receivers on the other. The appropriate balance is to be determined by the individual VRU device and is out of scope for the present document.
- The VAM sending device may have a limited number of pseudonym certificates and may reuse certificates from time to time, creating the ability for an eavesdropper to determine that all instances of use of a particular certificate are associated with the same device.
- The VAM sending device may (hypothetically) have certificates with different characteristics from the certificates used by neighbouring devices, for example in terms of validity period start time, end time, or duration. This allows an eavesdropper to identify a VRU device as a member of the group that got certificates with those characteristics, reducing the privacy depending on the size of that group.

The last two bullet points in the list above are intended to be addressed by a certificate policy that will specify numbers of certificates, certificate update policy, and certificate contents for VRUs. That policy is out of scope for the present document, although the present document recommends that such a policy is developed.

## 6.6 Methods to prevent false warnings (false positives)

### 6.6.1 General Considerations

The false warnings could create dangerous situations for VRUs, and other road users. False warning and reactions to those warnings may create network congestion in some scenarios. To prevent the false warnings the following techniques may be used depending on specific applications and implementations:

- Ruling out false positive warnings based on contextual information.
- Using redundancy. Verifying the warning using other available means based on the ITS messages received from other ITS-Ss or onboard sensors.
- Consistent warnings required for triggering actions. The threshold values for triggering warnings could be chosen with enough tolerance for seeing consistent warnings during adjacent message cycles.

- The sensor measurements for warning generation are periodically calibrated and confidence levels for measurements are accurately indicated.

The prevention of false warning is the responsibility of both the originating ITS-S and receiving IT-S. The VAM originating ITS-Ss may check the consistency of the information they are disseminating. For example:

- The location information in VAM and inferred location from past locations, speed, VAM reporting frequency, acceleration information and heading should agree within reasonable margin.
- The speed information in the VAM and inferred speed from past location, current location, acceleration information and VAM reporting frequency should agree within reasonable margin. The speed in the VAM should be reasonable for the VRU profile and sub-profiles.
- Acceleration information in the VAM and inferred acceleration information from past and current speeds, heading and VAM reporting frequency should agree within reasonable margin. Accelerations in the VAM should be reasonable for the VRU profile and sub-profiles.
- Heading, curvature, yaw rate and VRU orientation in the VAM should agree with the trend from the past locations.
- For the recommended safe distance (lateral, longitudinal, vertical) calculations, accurate locations of ego-VRU and other ITS-S are necessary. The locations of other ITS-S may be obtained via C-ITS messages or other means. The consistency check for own location and received or estimated locations of other ITS-S could be performed as described above.
- For the Time To Collision (TTC) calculation, accurate kinematic parameters of ego-VRU and other ITS-Ss are necessary. From own information and received ITS messages, consistency checks for kinematic parameters of ego-VRU and other ITS-S could be performed.
- For the trajectory interception calculations, accurate kinematic parameters of ego-VRU and other ITS-S are necessary. The consistency checks for own and received kinematic parameters could be performed.
- The stability loss could be verified using vertical position or other means using onboard sensors if available.

The receiving ITS-Ss would do the consistency checks for their own kinematics information and kinematics information received in VAMs from other VRU ITS-Ss in the same way as described above to identify the false warnings. It is the responsibility of the VRUs or the person operating the VRU (e.g. person riding on a bicycle) to identify the false positive warnings and avoid accidents.

## 6.6.2 Roadworks safety

False warnings regarding roadworks are filtered out more confidently if DENM and VAM are used together for vehicles or VRUs. If there is a DENM to indicate that there is a road work area ahead, plus VAMs sent by the road workers, any ITS-S that receives both types of messages can be aware of the road worker VRUs confidently.

## 6.6.3 Weather condition

The Time To Collision (TTC) can be estimated by the VRU ITS-S receiving the safety messages from other ITS-Ss. The dynamic motion properties (i.e. velocity, acceleration, heading, etc.) of VRU ITS-S or vehicle ITS-S are influenced by external conditions such as weather, road conditions. For example, if it rains, the road might be more slippery and the Vehicle ITS-S's braking distance will increase.

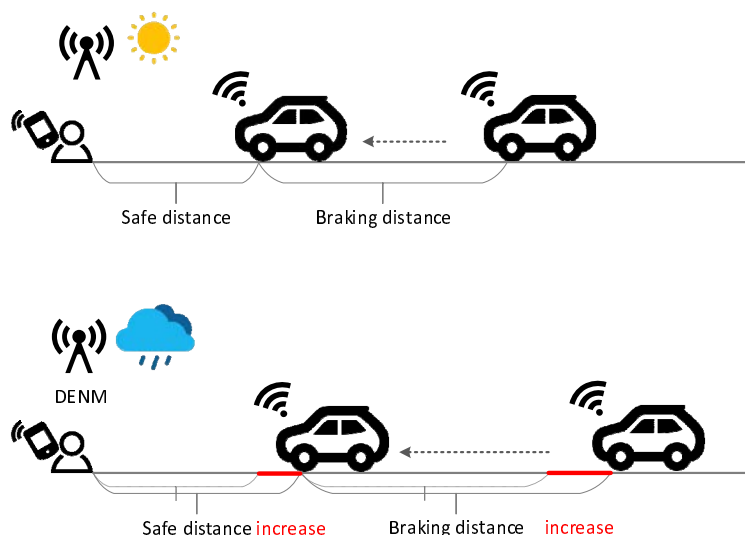

**Figure 5: Increased threshold distances after receiving DENM**

The VRU ITS-S can implement the VBS to consider the external condition such as weather and road condition when it receives DENM containing the cause code type as listed below.

```
CauseCodeType ::= INTEGER {
  adverseWeatherCondition-Adhesion (6),
  adverseWeatherCondition-ExtremeWeatherCondition (17),
  adverseWeatherCondition-Visibility (18),
  adverseWeatherCondition-Precipitation (19),
} (0..255)
```

The VRU ITS-S application can be implemented to increase the threshold safe distance between the VRU ITS-S and Vehicle ITS-S if it receives DENM indicating the adverse weather condition such as slippery road. Also, the VRU ITS-S application can be implemented to consider that the braking distance of the Vehicle ITS-S can be increased when it estimates the Time To Collision (TTC) if it receives DENM indicating the adverse weather condition.

## 6.7 Methods to prevent false negatives

The false negative situation arises when no warning message is transmitted during a dangerous situation. A false negative could be more critical for the safety of VRUs, and other road users than a false positive. To prevent the false negatives, the following techniques may be used depending on specific applications and implementations:

- Using redundancy. ITS-S may use different ways (type of sensors) to perceive the environment or estimate the kinematic attributes to predict the dangerous situation accurately.
- Generating warnings in the false negative situation based on contextual information.
- The sensor measurements for warning generation are periodically calibrated and confidence levels for measurements are accurately indicated.

It is again the responsibility of the VRUs or the person operating the VRU (e.g. person riding on a bicycle) to detect the false negative situation or danger and avoid accidents.

## 7 VAM Format Specification

### 7.1 General Structure of a VAM PDU

A VAM is composed of:

- a common ITS PDU header;
- a generation time;
- a basic container;
- a VRU high frequency container with dynamic properties of the VRU (motion, acceleration, etc.);
- a VRU low frequency container with physical properties of the VRU (conditional mandatory, e.g. with higher periodicity, see clause 7.3.2);
- a cluster information container (optional);
- a cluster operation container (optional);
- a motion prediction container (optional).

NOTE: The VAM is extensible, but no extensions are defined in the present document.

An illustration of the VAM structure is provided in Figure 6. Detailed data presentation rules shall be as specified in annex A.

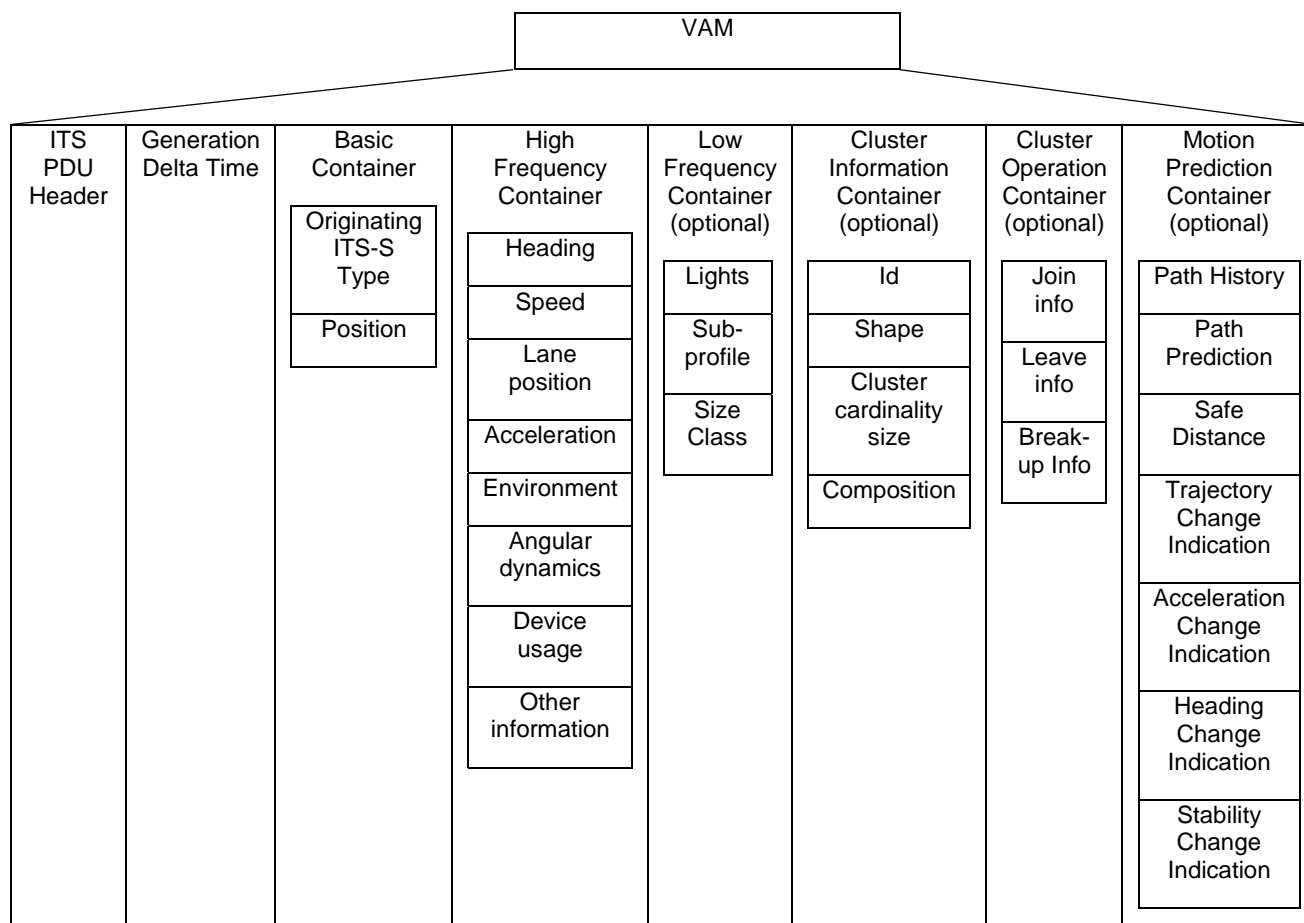

Figure 6: General structure of a VAM

## 7.2 ITS PDU header

The ITS PDU header shall be as specified in ETSI TS 102 894-2 [7]. Detailed data setting rules of the ITS PDU header in the context of VAM shall be as follows:

- For the present document and version, the value of the DE protocolVersion shall be set to 3.
- For VAM, the DE messageID shall be set to vam(16).
- The StationID shall be locally unique.

The *StationId* field in the ITS PDU Header shall change when the signing pseudonym certificate changes, or when the VRU starts to transmit individual VAMs after being a member of a cluster (i.e. either when, as leader, it breaks up the cluster, or when, as any cluster member, it leaves the cluster).

**Exception:** if the VRU device experiences a "failed join" of a cluster as defined in clause 5.4.2.2, it should continue to use the *StationId* and other identifiers that it used before the failed join.

The generation time in the VAM is a *GenerationDeltaTime*. It corresponds to the time of the reference position in the VAM, considered as time of the VAM generation. This is a measure of the number of milliseconds elapsed since the ITS epoch, modulo  $2^{16}$  (i.e. 65 536).

## 7.3 Other containers

### 7.3.1 Basic container

The basic container provides basic information of the originating ITS-S:

- Station type of the originating ITS-S; this DE somehow overlaps with the VRU profile, even though they do not fully match (e.g. moped(3) and motorcycle(4) both correspond to a VRU profile 3). To enable a future possibility to have the VAM transmitted by non VRU ITS-S (see clause 4.1 and annex I), both data elements are kept independent. This DE shall take the following values: pedestrian(1), bicyclist(2), moped(3), motorcycle(4), lightVRUvehicle(12), or animal(13). Other values of stationType shall not be used in the basicContainer transmitted in the VAM.
- The latest geographic position of the originating ITS-S as obtained by the VBS at the VAM generation. It provides the position and position confidence measured at the reference point of the originating ITS-S. The measurement time shall correspond to generationDeltaTime described in clause 7.2. If the station type of the originating ITS-S is set to one out of the values listed above, the reference point shall be the ground position of the centre of the front side of the bounding box of the VRU. As a reminder, this DF is defined in ETSI TS 102 894-2 [7] and includes a positionConfidenceEllipse which provides the confidence of the measured position with the 95 % confidence level.

The basic container shall be present for VAM generated by all ITS-Ss implementing the VBS.

### 7.3.2 VRU specific containers

All VAMs generated by a VRU ITS-S shall include at least a VRU High Frequency (VRU HF) container. The VRU HF container contains potentially fast-changing status information of the VRU ITS-S such as heading or speed.

**NOTE:** As the VAM is not used by VRUs from profile 3 (motorcyclist), none of these containers apply to VRUs profile 3. Instead, VRUs profile 3 only transmit the motorcycle special container with the CAM (see clause 4.1, clause 7.4 and clause 4.4 in ETSI TS 103 300-2 [1]).

In addition, VAMs generated by a VRU ITS-S may include one or more of the containers, as specified in Table 7, if relevant conditions are met. Other containers may be added in the future.

**Table 7: VAM conditional mandatory and optional containers**

Container name	Description	Condition for presence in the VAM
VRU Low Frequency (VRU LF) container	The VRU LF container contains static or slow-changing vehicle data like the profile or the status of the exterior lights.	Mandatory with higher periodicity (see clause 6.2) or when VRU cluster operation container is present
VRU cluster information container	This container provides the information/parameters relevant to a VRU cluster.	Conditional mandatory (see clause 5.4.1)
VRU cluster operation container	This container provides information relevant to change of cluster state in the VBS. It may be included by a cluster VAM transmitter or by a cluster member (respectively leader or ordinary member).	Conditional mandatory (see clause 5.4.1)
VRU motion prediction container	When the information is available in the VRU ITS-S, this container provides dynamic VRU motion prediction information as well as explicit path prediction.	Optional

Next clauses explain the VRU specific Data Elements (DE) of the different containers.

### 7.3.3 VAM VRU HF container

The VRU HF container of the VAM contains potentially fast-changing status information of the VRU ITS-S. It shall include the parameters listed in annex A.

Part of the information in this container do not make sense for some VRU profiles. Accordingly, they are indicated as optional, but recommended to specific VRU profiles.

NOTE 1: The VRU profile is included in the VRU LF container and so is not transmitted as often as the VRU HF container (see clause 6.2). However, the receiver may deduce the VRU profile from the *stationType* field: pedestrian indicates profile 1, bicyclist or lightVRUvehicle indicates profile 2, moped or motorcycle indicates profile 3, and animal indicates profile 4.

- The *curvatureValue* of the *curvature* DF is denoted as inverse of the VRU current curve radius and the turning direction of the curve with regards to the moving direction of the VRU.
- The *yawRate* component shall include the *yawRateValue* which denotes the VRU rotation around the centre of mass of the empty vehicle or VRU living being. The leading sign denotes the direction of rotation. The value is negative if the motion is clockwise when viewing from the top (in street coordinates).
- The *lateralAcceleration* component shall indicate the VRU vehicle lateral acceleration in the street plane, perpendicular to the heading direction of the originating ITS-S in the centre of the mass of the empty VRU vehicle (for profile 2) or of the human or animal VRU (for profile 1 or 4). This DE shall be present if the data is available at the originating ITS-S.
- The DF used to describe the lane position in CAM [6] is not sufficient when considering VRUs, as it does not include bicycle paths and sidewalks. Accordingly, it has been extended to cover all positions where a VRU could be located. When present, the *vrulanePosition* DF shall either describe a lane on the road (same as for a vehicle), a lane off the road or an island between two lanes of the previous types. Further details are provided in the DF definition, in ETSI TS 102 894-2 [7].

NOTE 2: Additional information is needed to unambiguously identify the lane position and to allow the correlation to a map. This is linked to an adequate geolocation precision.

- The *orientation* DF complements the dimensions of the VRU vehicle by defining the angle between the VRU vehicle longitudinal axis with regards to the WGS84 north. It is restricted to VRUs from profile 2 (bicyclist) and profile 3 (motorcyclist). When present, it shall be as defined ETSI TS 102 894-2 [7]. The *orientation* angle is different from the vehicle heading, which is related to the VRU movement while the orientation is related to the VRU position. The orientation of the VRU is an important factor, especially in the case where the VRU has fallen on the ground after an accident and constitutes a non moving obstacle to other road users.

- The *rollAngle* DF provides an indication of a cornering two-wheeler. It is defined as the angle between the ground plane and the current orientation of a vehicle's y-axis with respect to the ground plane about the x-axis as specified in ISO 8855 [15]. The DF also includes the angle accuracy. Both values are coded with the following conventions:
  - Positive values mean rolling to the right side (0..."500"), where 500 corresponds to a roll angle value to the right of 50 degrees.
  - Negative values mean rolling to the left side (3 600..."3 100"), where 3 100 corresponds to a roll angle value to the left of 50 degrees.
  - Values between 500 and 3 100 shall not be used.
- The *deviceUsage* DE provides indications to the VAM receiver about a parallel activity of the VRU. This DE is similar to the *DE\_PersonalDeviceUsageState* specified in SAE J2945/9 [i.10]. It is restricted to VRUs from profile 1, e.g. pedestrians. When present, it shall provide the possible values given in Table 8. To respect the user's choice for privacy, the device configuration application should include a consent form for transmitting this information. How this consent form is implemented is out of scope of the present document. In the case the option is opted-out (default), the device shall systematically send the value "unavailable(0)".

**Table 8: vruDeviceUsage possible values**

Activity definition	Value	Description
unavailable	0	Not determined or VRU did not consent to transmission of this personal data in this DE
other	1	Used for states other than defined below
idle	2	Human is not interacting with device
listeningToAudio	3	Any audio source other than calling
typing	4	Including texting, entering addresses and other manual input activity
calling	5	
playingGames	6	
reading	7	
viewing	8	Watching dynamic content, including following navigation prompts, viewing videos or other visual contents that are not static

- The *movementControl* DE indicates the mechanism used by the VRU to control the longitudinal movement of the VRU vehicle. It is mostly aimed at VRUs from profile 2, e.g. bicyclists. When present, it will provide the possible values given in Table 9. The usage of the different values provided in the table may depend on the country where they apply. For example, a pedal movement could be necessary for braking, depending on the bicycle in some countries. This DE could also serve as information for the surrounding vehicles' on-board systems to identify the bicyclist (among others) and hence improve/speed up the "matching" process of the messages already received from the VRU vehicle (before it entered the car's field of view) and the object which is detected by the other vehicle's camera (once the VRU vehicle enters the field of view). The impact of this mechanism may be indicated by other DEs in the *vruMotionPredictionContainer* (e.g. *headingChangeIndication*, *accelerationChangeIndication*).

**Table 9: VruMovementControl possible values**

Movement control applied	Value	Description
unavailable	0	Not determined or VRU did not consent to transmission of this personal data in this DE
braking	1	Action applied on VRU vehicle brakes
hardBraking	2	Action applied on VRU vehicle brakes
stopPedaling	3	Action applied on VRU vehicle pedals
brakingAndStopPedaling	4	Action applied on both VRU vehicle pedals and brakes
hardBrakingAndStopPedaling	5	Action applied on both VRU vehicle pedals and brakes
noReaction	6	No action applied on VRU vehicle

### 7.3.4 VAM VRU LF container

The VRU LF container of the VAM contains potential slow-changing information of the VRU ITS-S. It shall include the parameters listed in annex A.

The VRU LF container shall be included into the VAM with a parametrizable frequency as specified in clause 6.2. The VAM VRU LF container has the following content:

- The *profileAndSubprofile* DE shall contain the identification of the profile and the sub-profile of the originating VRU ITS-S if defined. Table 10 shows the list of profiles and sub-profiles specified in the present document.

The setting rules for this value are out of the scope of the present document, see ETSI TS 103 300-2 [1]. The profile identifies the four types of VRU profiles specified in ETSI TS 103 300-2 [1]: pedestrian, bicyclist, motorcyclist, and animal. The profile type names are descriptive: for example, a human-powered tricycle would conform to the bicyclist profile. The subProfile identifies different types of VRUs within a profile.

**Table 10: VruProfileAndSubProfile description based on profiles**

Profile	Profile Index	SubProfile Index	VruSubProfile description
Pedestrian	1	0	Unavailable
		1	Ordinary Pedestrian
		2	Road workers
		3	First responder
Bicyclist	2	0	Unavailable
		1	Bicyclist
		2	Wheelchair User
		3	Horse and rider
		4	Rollerskater
		5	Standing E-Scooter
		6	Personal Transporter
		7	E-Bicyclist (Pedelec), up to 25 km/h in Europe
Motorcyclist	3	0	Unavailable
		1	Moped
		2	Motorcycle
		3	Motorcycle + Sidecar right
		4	Motorcycle + Sidecar left
		5	Seated E-scooter
Animal (see note)	4	0	Unavailable
		1	Wild animal
		2	Farm animal
		3	Service animal
NOTE: In the context of safety related traffic communication, animals are regarded having a higher priority than non-living objects. Thus, a specific profile has been defined in order to treat them correctly in any kind of decision-making process.			

The *profileAndSubprofile* DE is MANDATORY if the VRU LF container is present.

NOTE: The sub-profiles for VRU profile 3 are used only in the CAM special container.

- The *sizeClass* DE contains information of the size of the VRU. The size class is interpreted in combination with the profile type to get the range of dimensions of the VRU. The sizeClass shall depend on the VRU profile. This dependency is depicted in Table 11.

**Table 11: VruSizeClass description based on profiles**

Profile	Profile Value	VruSizeClass Value	VruSizeClass description
Unavailable	0	0	N/A
Pedestrian	1	0	Unavailable
		1	Low → 1 m or less in height
		2	medium → larger than 1 m and 1,5 m or less in height
		3	high → larger than 1,5 m
Bicyclist	2	0	Unavailable
		1	Low → 1,5 m or less height



Profile	Profile Value	VruSizeClass Value	VruSizeClass description
		2	medium → more than 1,5 m in height, 1 m or less front-to-back
		3	high → more than 1,5 m in height, more than 1 m front-to-back
Motorcyclist	3	0	Unavailable
		1	Low → 1,5 m or less height
		2	medium → more than 1,5 m in height, 1 m or less front-to-back
		3	high → more than 1,5 m in height, more than 1 m front-to-back
Animal	4	0	Unavailable
		1	Low → 60 Kg or less and 1,5 m or less height
		2	medium → more than 60 kg and 100 kg or less and 1,5 m or less in height
		3	high → more than 100 kg or more than 1,5 m in height
NOTE: 1,5 m height of a VRU as a limit makes the difference between being obscured by a parked car and not being obscured by a parked car.			

- The *exteriorLights* DF shall give the status of the most important exterior lights switches of the VRU ITS-S that originates the VAM. The DE *VruExteriorLight* shall be optional for all VRU profiles, except under the following condition: for VRU profile 2, the *exteriorLights* DF shall be present if the data is available at the originating ITS-S.

### 7.3.5 VAM VRU cluster containers

The VRU cluster containers of the VAM contain the cluster information and/or operations related to the VRU clusters of the VRU ITS-S. The VRU cluster containers are made of two types of cluster containers according to the characteristics of the included data/parameters:

- A VRU cluster information container shall be added to a VAM originated from the VRU cluster leader. This container shall provide the information/parameters relevant to the VRU cluster. VRU cluster information container shall be of type *VruClusterInformationContainer*.
- VRU cluster information container shall comprise information about the cluster ID, shape of the cluster bounding box, cardinality size of cluster and profiles of VRUs in the cluster. Cluster ID is of type *ClusterID*. *ClusterID* is selected by the cluster leader to be non-zero and locally unique as specified in clause 5.4.2.2. The shape of the VRU cluster bounding box shall be specified by DF *ClusterBoundingBoxShape*. The shape of the cluster bounding box can be rectangular, circular or polygon.
- If the component *clusterProfiles* is present in the VRU cluster information container, it shall not be set to all 0s if VRU own profile is pedestrian(1), bicyclist(2), or animal(4), as the sender knows that it itself is within the cluster.
- VRU cluster operation container shall contain information relevant to change of cluster state and composition. This container may be included by a cluster VAM transmitter or by a cluster member (leader or ordinary member). A cluster leader shall include VRU cluster operation container for performing cluster operations of disbanding (breaking up) cluster. A cluster member shall include VRU cluster operation container in its individual VAM to perform cluster operations of joining a VRU cluster and leaving a VRU cluster.
- VRU cluster operation container shall be of type *VruClusterOperationContainer*. *VruClusterOperationContainer* provides:
  - *clusterJoinInfo* for cluster operation of joining a VRU cluster by a new member. The *clusterId* is identical to the *clusterId* component in the *vruInformationClusterContainer* in the VAM describing the cluster that the sender of the *clusterJoinInfo* intends to join. In this case, the *joinTime* indicates a time after which the VAM transmitter will stop transmitting individual VAMs.

- *clusterLeaveInfo* for an existing cluster member to leave a VRU cluster. The *clusterId* is identical to the *clusterId* component in the *VruClusterInformationContainer* in the VAM describing the cluster that the sender of the *clusterLeaveInfo* has recently left. The *clusterLeaveReason* indicates the reason why the sender of *ClusterLeaveInfo* has recently left the cluster, as specified in Table 12.
- *clusterBreakupInfo* to perform cluster operations of disbanding (breaking up) cluster respectively by the cluster leader. The *clusterBreakupReason* indicates the reason why the sender of *clusterBreakupInfo* intends to break up the cluster, as specified in Table 13. The *breakupTime* indicates a time after which the VAM transmitter will stop transmitting cluster VAMs.
- *clusterIdChangeTimeInfo* to indicate that the cluster leader is planning to change the cluster ID at the time indicated in the DE. The new Id is not provided with the indication for privacy reasons (see clause 5.4.2.3 and clause 6.5.4).

A VRU device joining or leaving a cluster announced in a message other than a VAM shall indicate this using the ClusterId value 0.

A VRU device leaving a cluster shall indicate the reason why it leaves the cluster using the DE *ClusterLeaveReason*. The available reasons are depicted in Table 12. A VRU leader device breaking up a cluster shall indicate the reason why it breaks up the cluster using the *ClusterBreakupReason*. The available reasons are depicted in Table 13. In the case the reason for leaving the cluster or breaking up the cluster is not exactly matched to one of the available reasons, the device shall systematically send the value "notProvided(0)".

In particular, a VRU in a cluster, may determine that one or more new vehicles or other VRUs (e.g. VRU Profile 3 - Motorcyclist) have come closer than Minimum Safe Lateral Distance (MSLaD) laterally, and closer than Minimum Safe Longitudinal Distance (MSLoD) longitudinally and closer than Minimum Safe Vertical Distance (MSVD) vertically (the minimum safe distance condition is satisfied as in clause 6.5.10.5 of ETSI TS 103 300-2 [1]); it shall leave the cluster and enter VRU-ACTIVE-STANDALONE VBS state in order to transmit immediate VAM with *ClusterLeaveReason* "SafetyCondition(8)". The same applies if any other safety issue is detected by the VRU device.

NOTE: Device suppliers should declare the conditions on which the VRU device will join/leave a cluster.

**Table 12: ClusterLeaveReason description**

Name	Value	Description
ClusterLeaveReason	0	notProvided
	1	clusterLeaderLost
	2	clusterDisbandedByLeader
	3	outOfClusterBoundingBox
	4	outOfClusterSpeedRange
	5	joiningAnotherCluster
	6	CancelledJoin
	7	FailedJoin
	8	SafetyCondition

**Table 13: ClusterBreakupReason description**

Name	Value	Description
ClusterBreakupReason	0	notProvided
	1	clusteringPurposeCompleted
	2	leaderMovedOutOfClusterBoundingBox
	3	joiningAnotherCluster
	4	enteringLowriskareaBasedonMAPs
	5	receptionOfCPMcontainingCluster

The *VruClusterOperationContainer* does not include the creation of VRU cluster by the cluster leader. When the cluster leader starts to send a cluster VAM, it indicates that it has created a VRU cluster. While the cluster leader is sending a cluster VAM, any individual VRUs can join the cluster if the joining conditions are met.

### 7.3.6 VAM VRU Motion Prediction container

The VRU Motion Prediction Container carries the past and future motion state information of the VRU. The VRU Motion Prediction Container of type *VruMotionPredictionContainer* shall contain information about the past locations of the VRU of type *PathHistory*, predicted future locations of the VRU, safe distance indication between VRU and other road users/objects of type *SequenceOfSafeDistanceIndication*, VRU's possible trajectory interception with another VRU/object shall be of type *SequenceOfTrajectoryInterceptionIndication*, the change in the acceleration of the VRU shall be of type *AccelerationChangeIndication*, the heading changes of the VRU shall be of *HeadingChangeIndication*, and changes in the stability of the VRU shall be of type *StabilityChangeIndication*:

- The *pathHistory* is of *PathHistory* type. The *PathHistory* DF shall comprise the VRU's recent movement over past time and/or distance. It consists of up to 40 past path points (see ETSI TS 102 894-2 [7]). When a VRU leaves a cluster and wants to transmit its past locations in the VAM, the VRU may use the *PathHistory* DF.
- The Path Prediction DF is of *PathPredicted* type and shall define up to 15 future path points, confidence values and corresponding time instances of the VRU ITS-S. It contains future path information for up to 10 seconds or up to 15 path points, whichever is smaller.
- The Safe Distance Indication is of type *SequenceOfSafeDistanceIndication* and provides an indication of whether the VRU is at a recommended safe distance laterally, longitudinally and vertically from up to 8 other stations in its vicinity. The simultaneous comparisons between Lateral Distance (LaD), Longitudinal Distance (LoD) and Vertical Distance (VD) and their respective thresholds, Minimum Safe Lateral Distance (MSLaD), Minimum Safe Longitudinal Distance (MSLoD), and Minimum Safe Vertical Distance (MSVD) as defined in clause 6.5.10.5 of ETSI TS 103 300-2 [1], shall be used for setting the *safeDistanceIndicator* DF. Other ITS-S involved are indicated as *subjectStation* DE within the *SafeDistanceIndication* DE. The *timeToCollision* (TTC) DE within the container shall reflect the estimated time taken for collision based on the latest onboard sensor measurements and VAMs.
- The *trajectoryInterceptionIndication* shall contain ego-VRU's possible trajectory interception with up to 8 other stations in the vicinity of the ego-VRU. The trajectory interception of a VRU is indicated by *trajectoryInterceptionIndication* DF. The other ITS-S involved are designated by *StationID* DE. The trajectory interception probability and its confidence level metrics are indicated by *TrajectoryInterceptionProbability* and *TrajectoryInterceptionConfidence* DEs.

NOTE 1: The Trajectory Interception Indication (TII) DF corresponds to the TII definition in ETSI TS 103 300-2 [1].

- The *accelerationChangeIndication* shall contain ego-VRU's change of acceleration in the future (acceleration or deceleration) for a time period. The DE *accelOrDecel* shall give the choice between acceleration and deceleration. The DE *actionDeltaTime* shall indicate the time duration.
- The *headingChangeIndication* shall contain ego-VRU's change of heading in the future (left or right) for a time period. The DE *direction* shall give the choice between heading change in left and right directions. The DE *actionDeltaTime* shall indicate the time duration.
- The *stabilityChangeIndication* shall contain ego-VRU's change in stability for a time period. The *lossProbability* shall give the probability indication of the stability loss of the ego-VRU. It is expressed in the estimated probability of a complete VRU stability loss which may lead to a VRU ejection of its VRU vehicle. The loss of stability is projected for a time period *actionDeltaTime*.

NOTE 2: The description of the container is provided in annex A.

## 7.4 Special container for VRU Profile 3 (motorcyclist)

ITS stations in VRUs profile 3 devices (motorcyclist) already transmit the CAM. Accordingly, as specified in ETSI TS 103 300-2 [1] and in clause 5, they shall not transmit the full VAM but may transmit a VRU special vehicle container in the CAM that they already transmit. When relevant, this requirement also applies in case of a combined VRU (see clause 5.4.2.6) made of one VRU profile 3 (motorcycle) and one or more VRU profile 1 (pedestrian(s)).

The objective of this special vehicle container is to notify to surrounding vehicles that the V-ITS-S is hosted by a VRU Profile 3 device and to provide additional indications about the VRU profile 3. The *Motorcyclist special container* shall include the parameters listed in clause D.2.

## 7.5 VAM format and coding rules

### 7.5.1 Common data dictionary

The VAM format shall make use of the Common Data Dictionary (CDD) as defined in ETSI TS 102 894-2 [7].

Where applicable, DEs and DFs that are not defined in the present document shall be imported from the CDD as specified in ETSI TS 102 894-2 [7].

NOTE 1: Detailed descriptions of all DEs and DFs setting in the context of VAM are presented in annex B of the present document.

NOTE 2: Detailed descriptions of all DEs and DFs setting in the context of the VRU special container for CAM, applicable to VRUs Profile 3, are presented in annex D of the present document.

### 7.5.2 VAM data presentation

The VAM format is presented in ASN.1. Unaligned Packed Encoding Rules (PER) as defined in Recommendation ITU-T X.691/ISO/IEC 8825-2 [16] shall be used for VAM encoding and decoding.

The ASN.1 representation of VAM shall be as specified in annex A of the present document.

---

## 8 Parameters values

The present clause provides the values to be used for the parameters defined in clauses 5 to 7.

The parameters in Table 14 govern the VRU decision to create, join or leave a cluster. The parameters may be set on individual devices or system wide and may depend on external conditions or be independent of them.

**Table 14: Parameters for VRU clustering decisions (clause 5.4.2)**

Parameter	Type	Meaning	Recommended range
numCreateCluster	Integer	number of VRU devices that a potential cluster leader anticipates will join a cluster, if one is created.	[3 to 5]
maxClusterDistance	distance (in m)	maximum distance between the edge of the cluster and the VRU performing the evaluation. This value also restricts the size of a VRU cluster.	[3 to 5]
maxClusterVelocityDifference	percentage	maximum speed velocity difference inside a cluster.	5 %
maxCombinedClusterDistance	distance (in m)	maximum distance between the edge of the combined VRU cluster and the VRU performing the evaluation. This value also restricts the size of a combined VRU cluster.	[1 to 2]
minClusterSize	Integer	minimal size of a VRU cluster. It is used to fill the <i>clusterCardinalitySize</i> field, just after creation and before any VRU has joined (see note 1).	1
maxClusterSize	Integer	maximal size (or number of active ITS-S) of a VRU cluster. It is used by a VRU to check whether it can join the cluster. In practice, the cluster may be larger and include non-equipped VRUs, which cannot take part in the clustering operation and be identified as such by the cluster leader.	20 (see note 2)
numClusterVAMRepeat	Integer	number of VAM repetitions with former identifiers in case of a cluster cancelled-join or a failed-join.	3

Parameter	Type	Meaning	Recommended range
NOTE 1: The minimal size of 1 for the cluster cardinality size does not mean any VRU can be its own cluster as a VRU should comply with the criteria set in clause 5.4.2.4 before it creates a cluster. This value is set to 1 to reflect the cluster condition just after it was created and before any other VRU has had an opportunity to join.			
NOTE 2: The value given in the present document is an initial indicative value. It may be revised in a later revision after more evaluations of clustering have been performed.			

The parameters in Table 15 govern the messaging behaviour around joining and leaving clusters. The parameters may be set on individual devices or system wide and may depend on external conditions or be independent of them.

**Table 15: Cluster membership parameters (clause 5.4.2)**

Parameter	Type	Meaning	Recommended default value
timeClusterUniquenessThreshold	Time period	When a cluster leader selects a cluster ID, it has to be different from any cluster ID received by the cluster leader within this time	30 seconds
timeClusterBreakupWarning	Time period	When a cluster leader has made the decision to end a cluster, it includes in its VAMs an indication of the forthcoming end of the cluster for this time	3 seconds
timeClusterJoinNotification	Time period	When a VRU device sending individual VAMs intends to join a cluster, it includes in its VAMs an indication of this intention for this time	3 seconds
timeClusterJoinSuccess	Time period	After a VRU device joins a cluster, it waits this amount of time for the cluster VAM to reflect the fact that the VRU device has joined and leaves the cluster if not	0,5 seconds
timeClusterIdChangeNotification	Time period	The time for which a cluster leader advertises that it is going to change its ID before changing it	3 seconds
timeClusterIdPersist	Time period	If the cluster ID for a particular device changes, the time for which it can continue to use the old ID in a cluster leave indication	3 seconds
timeClusterContinuity	Time period	If a VRU device that is a member of a cluster does not receive a cluster VAM for this period of time, it leaves the cluster	2 seconds
timeClusterLeaveNotification	Time period	After a VRU device has left a cluster, it includes in its VAMs an indication of the cluster it has left for this time	1 second
timeCombinedVruClusterOpportunity	Time period	The time for which an ITS-S advertises that it is offering to form a combined VRU cluster	15 seconds

Table 16 shows the parameters for a VAM generation. The parameters may be set on individual devices or system wide and may depend on external conditions or be independent of them.

**Table 16: Parameters for VAM generation (clause 6.2)**

Parameter	Type	Meaning	Recommended value
T_GenVamMin	Time in ms	The minimum time elapsed between the start of consecutive VAM generation events. For VRU LF container 2 000 ms shall be used	100
T_GenVamMax	Time in ms	The maximum time elapsed between the start of consecutive VAM generation events	5 000
T_AssembleVAM	Time in ms	The time allocated for assembling a VAM packet in the facilities layer	50

The parameters in Table 17 govern the VAM generation triggering. The parameters may be set on individual devices or system wide and may depend on external conditions or be independent of them.

Table 17: Parameters for VAM generation triggering (clause 6.4)

Parameter	Type	Meaning	Recommended range
minReferencePointPositionChangeThreshold	distance (in m)	Minimum Euclidian absolute distance between the current estimated position of the reference point of the VRU (or VRU cluster) and the estimated position of the reference point lastly included in a VAM in order to trigger VAM generation based on position change of VRU (or VRU cluster). This restricts triggering VAM generation.	4
minGroundSpeedChangeThreshold	Speed (in m/s)	Minimum difference between the current estimated ground speed of the reference point of the VRU (or VRU cluster) and the estimated absolute speed of the reference point of the VRU (or VRU Cluster) lastly included in a VAM in order to trigger VAM generation based on speed change of VRU (or VRU cluster). This restricts triggering VAM generation.	±0,5
minGroundVelocityOrientationChangeThreshold	orientation (in degrees)	Minimum difference between the orientation of the vector of the current estimated ground velocity of the reference point of the VRU (or VRU cluster) and the estimated orientation of the vector of the ground velocity of the reference point of the VRU (or VRU cluster) lastly included in a VAM in order to trigger VAM generation based on change in orientation of the vector of the ground velocity of VRU (or VRU cluster). This restricts triggering VAM generation.	±4
minTrajectoryInterceptionProbChangeThreshold	Probability (in percentage)	Minimum difference between the current estimated Trajectory Interception probability of VRU (or VRU cluster) with vehicle(s) or other VRU(s) and the estimated collision probability of VRU (or VRU cluster) with vehicle(s) or other VRU(s) lastly reported in a VAM in order to trigger VAM generation based on Trajectory Interception probability change of VRU (or VRU cluster). This restricts triggering VAM generation.	10
numSkipVamsForRedundancyMitigation	Number of times	If conditions are satisfied for redundancy mitigation, an originating VRU ITS-S shall skip current individual VAM <i>numSkipVamsForRedundancyMitigation</i> times.	[2 to 10]
minClusterDistanceChangeThreshold	length (in m)	Minimum difference between the current estimated distance from the VRU cluster boundary and the estimated distance based on the last transmitted VAM in order to trigger VAM generation based on VRU cluster bounding box size change. This restricts triggering VAM generation.	2

Parameter	Type	Meaning	Recommended range
minimumSafeLateralDistance (MSLaD)	length (in m)	Minimum safe lateral distance between ego-VRU and another traffic participant (equipped or not). It depends on the ego-VRU profiles, their speeds, and the other traffic participants' profiles and their speeds. The maximum value between 2 m and lateral distance ego-VRU could travel in $T\_GenVamMax$ seconds is set as MSLaD. A = the lateral distance ego-VRU could travel in $T\_GenVamMax$ seconds.	Max [2, A]
minimumSafeLongitudinalDistance (MSLoD)	length (in m)	Minimum safe longitudinal distance between ego-VRU and another traffic participant (equipped or not). It depends on the ego-VRU profiles, their speeds, and the other traffic participants' profiles and their speeds. B = the longitudinal distance ego-VRU could travel in $T\_GenVamMax$ seconds.	B
minimumSafeVerticalDistance (MSVD)	length (in m)	Minimum safe vertical distance between ego-VRU and another traffic participant (equipped or not). The overpass normally has 5 m clearance.	5

---

## Annex A (normative): ASN.1 specification of VAM

The ASN.1 modules specified in the present document are available at the following URL:

- [https://forge.etsi.org/rep/ITS/asn1/vam-ts103300\\_3/-/tree/v.2.2.1](https://forge.etsi.org/rep/ITS/asn1/vam-ts103300_3/-/tree/v.2.2.1)

Two ASN.1 modules are defined to support the present specification:

- VAM-PDU-Descriptions.asn with OID:

```
{itu-t(0) identified-organization(4) etsi(0) itsDomain(5) wg1(1) 103300 vam(1) major-version-3(3)
minor-version-1(1)}
```

- motorcyclist-special-container.asn (recommended for inclusion in the CAM) with OID:

```
{itu-t(0) identified-organization(4) etsi(0) itsDomain(5) wg1(1) 103300 motorcyclist-special-
container(2) version2(2)}
```



---

## Annex B (normative): Description of data elements and data frames

The description of data elements and data frames specified in the present document is available at the following URL:

- [https://forge.etsi.org/rep/ITS/asn1/vam-ts103300\\_3/-/tree/v.2.2.1/docs](https://forge.etsi.org/rep/ITS/asn1/vam-ts103300_3/-/tree/v.2.2.1/docs).

The associated SHA-256 cryptographic hash digest of the referenced file offers a means to verify the integrity of that file. For the present version, the value are set as defined below:

- VAM-PDU-Descriptions.asn:

SHA-256 hash:5631c6d2534a7883fe329f9fe40f45b039e3c9d0611560ea7ef20d3a9ba3d11f.

- motorcyclist-special-container.asn (recommended for inclusion in the CAM):

SHA-256 hash:846a7517c3de316292e331e39cd69446d5a281a2fd0b73fff5d804b1022c2f0f.

---

# Annex C (informative): Protocol operation of the VRU basic service

## C.1 Introduction

This annex provides a timer-controlled approach for the protocol operation as one potential variant compliant to the present document. It is distinguished between the originating ITS-S operation and the receiving ITS-S operation considered in the following clauses.

The following specification of the protocol operation is organized in three parts:

- 1) Protocol data setting rules specify the setting of the relevant data elements used by the protocol.
- 2) Protocol rules related to VRU clustering are specified in clause 5.4.2.
- 3) The general protocol operation specifies the sequence of protocol operations.

Exception handling specifies additional protocol operations that extend the general protocol operation. They are applied when special conditions, referred to exceptions (for example inconsistent data) occur.

An ITS-S maintains a local data structure, referred to as "ITS-S message and clustering table". This data structure holds information about VRU role, clustering state and operations together with sent and received VAM messages.

It is out of the scope of the present document to describe how this data structure is implemented.

---

## C.2 Originating ITS-S operation

### C.2.1 Protocol data setting rules

The data setting for the originating ITS-S operation are specified in annex B.

### C.2.2 T\_CheckVamGen

The timer *T\_CheckVamGen* schedules the time at which the VAM generation conditions are checked by the VBS, its time out value is specified in clause 6.2.

### C.2.3 Protocol data

The VRU Basic Service (VBS) stores at least the following information for the VAM originating ITS-S operation:

- VAM generation time;
- ITS-S position as included in VAM;
- ITS-S speed as included in VAM;
- ITS-S heading as included in VAM;
- VRU role;
- VRU profile;
- VBS cluster state.

## C.2.4 General protocol operation

The originating ITS-S protocol starts when the VBS is activated. An originating ITS-S may execute the following operation:

- 1) Set *T\_CheckVamGen* and start the timer.
- 2) When the timer *T\_CheckVamGen* expires, check the VAM generation conditions:
  - a) If all the conditions are satisfied, then continue the operation.
  - b) If one condition is not satisfied, then skip step 3) to step 7).
- 3) Collect data for mandatory containers.
- 4) Check if optional containers are to be added for VAM generation:
  - a) If yes, collect data for optional containers.
  - b) If no, continue the operation.
- 5) Encode VAM.
- 6) Pass VAM to the selected networking & transport layer.
- 7) Save data required as specified in clause C.2.3 for next VAM generation.
- 8) Restart the timer *T\_CheckVamGen*.

## C.2.5 VAM construction exception

If the VBS could not construct a VAM successfully in step 5) as defined in clause C.2.4, the VBS is expected to omit step 6) to step 8) and is expected to restart the timer *T\_CheckVamGen*.

NOTE 1: The failure of the VAM construction may happen, if the VBS was not able to collect all required data for the VAM construction, or the collected data are not compliant to the VAM format as specified in annex A (e.g. the value of a data is out of authorized range of the ASN.1 definition).

NOTE 2: If the VAM construction failure was due to a data provided by other entities via the interface IF.OFa, the VBS may provide a failure notification to the corresponding data provision entity via the IF.OFa.

---

## C.3 Receiving ITS-S operation

### C.3.1 Protocol data setting rules

No protocol data need to be set for receiving ITS-S.

### C.3.2 General protocol operation

The ITS-S receiver protocol starts when the VBS receives a VAM and executes the following operations:

- 1) Decode the received VAM.
- 2) Check the relevance, integrity (conformity to annex A) and plausibility of the received VAM.
- 3) In case of a successful check, make VAM data available by e.g. passing to the ITS application layer or to the LDM; in this case, execute VBS clustering operations.
- 4) In case of a non-successful check, discard the VAM and provide a failure notification to the security layer.
- 5) End of operation wait for the next VAM reception.

### C.3.3 Exception handling

If the VBS could not decode a VAM successfully in step 1) as defined in clause C.3.2, the VBS omits steps 2) to step 4).

If the relevance check in step 2) indicates that the VRU is not in the relevance area of the receiving ITS-S, the VBS omits steps 3) to step 4).

The integrity or/and plausibility checks indicate that the VAM does not conform to the ASN.1 definition of annex A or/and contains data elements values which are not plausible with previously received values. In that case, the VBS should send a notification to the security entity in the receiving ITS-S.

## C.4 VBS protocol flowcharts

This clause illustrates the protocol operation of a transmitting VRU ITS-S. Figure C.1 illustrates the general protocol operation, while Figure C.2 illustrates the different paths for the optional clusters generation.

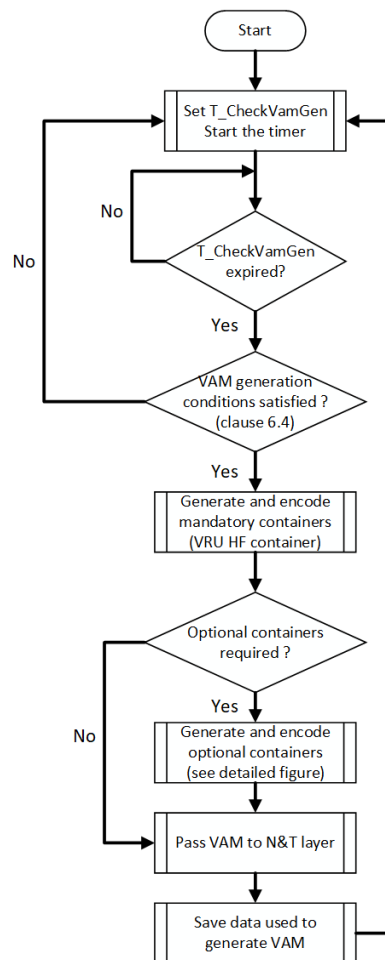

Figure C.1: VBS general protocol operation

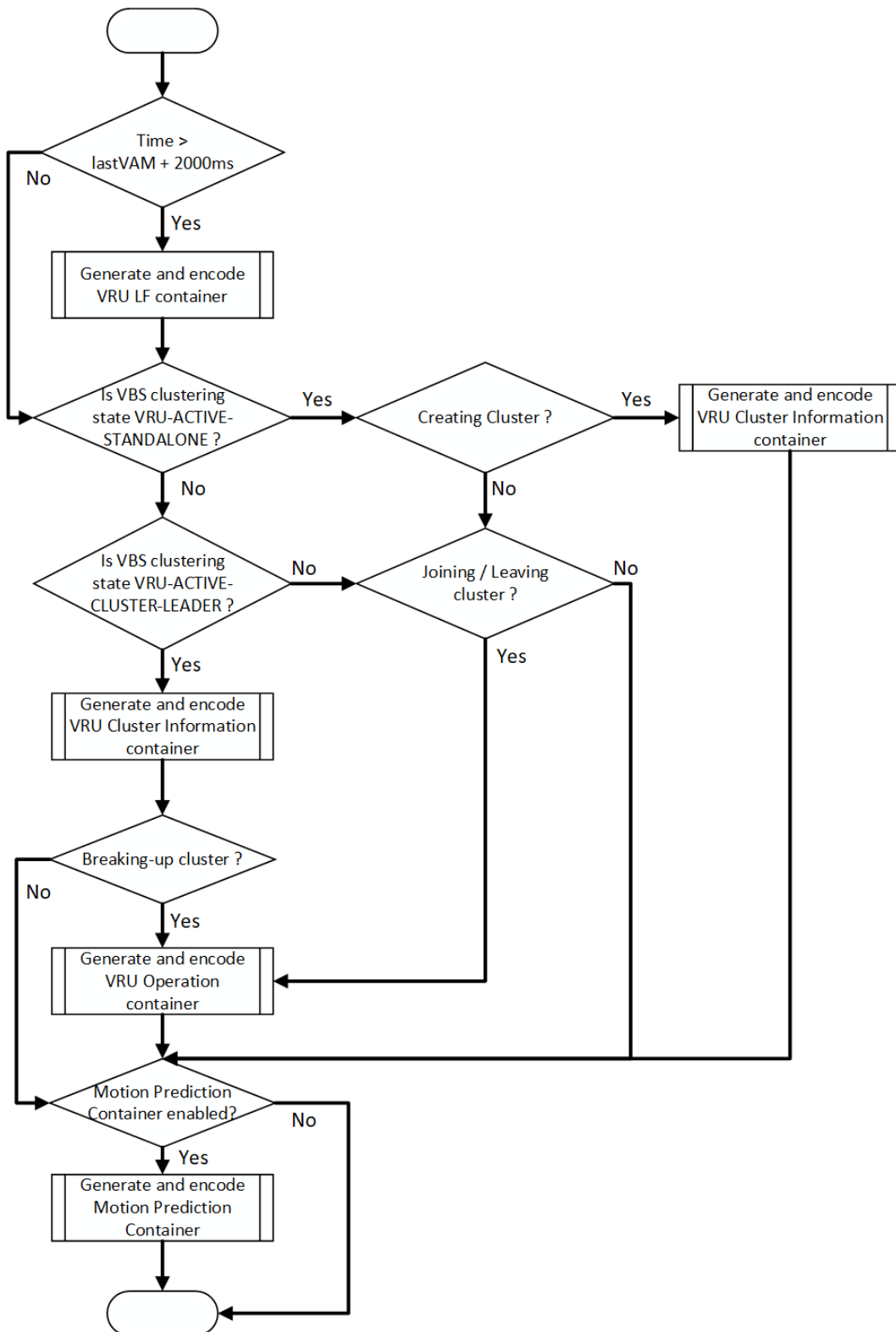

Figure C.2: Optional clusters generation

## Annex D (informative): Recommendation for CAM VRU special container applicable to VRUs Profile 3

### D.1 General consideration

As specified in ETSI TS 103 300-2 [1], VRUs from profile 3 (motorcyclist) do not send the VAM, but rather transmit an additional special container to the CAM they already transmit. The present annex D provides the list of the data elements to be included in the *specialVehicleContainer.MotorcyclistContainer* proposed to be added to the CAM standard (see clause 7.4).

The recommendation is to allocate the value *reserved1(13)* of *DE VehicleRole* specified in ETSI TS 102 894-2 [7] to define a role of motorcyclist associated to the *MotorcyclistContainer* defined in clause D.2.

### D.2 MotorcyclistContainer

<b>Description</b>	A container of the CAM included in the special vehicle container. if DE vehicleRole is set to VRUMotorcyclist(8) this container should be present.
<b>Data setting and presentation requirements</b>	<p>This DF will be presented as specified in annex A.</p> <p>The MotorcyclistContainer includes the following components (defined below):</p> <ul style="list-style-type: none"> <li>• vruSubProfileMotorcyclist, Mandatory (cf component of LF container described in clause 7.3.4)</li> <li>• sizeClass, Mandatory (cf. component of LF container described in clause 7.3.4)</li> <li>• rollAngle, Optional (cf component of HF container described in clause 7.3.3)</li> <li>• orientation, Optional (cf component of HF container described in clause 7.3.3)</li> <li>• vruSafeDistance, Optional (cf component of Motion Prediction container described in clause 7.3.6)</li> <li>• pathPrediction, Optional (cf component of Motion Prediction container described in clause 7.3.6)</li> <li>• stabilityChangeIndication, Optional (cf component of Motion Prediction container described in clause 7.3.6)</li> </ul> <p>These data elements are defined in annex A.</p>

---

Annex E:  
Void

---

Annex F:  
Void



---

# Annex G (informative): Additional elements for further study on VRU behaviour prediction

## G.0 Disclaimer

The present annex provides possible topics for further study that were contributed to the present document, but could not be included in the core of the specification.

---

## G.1 Overview

Vulnerable Road Users present a diversity of profiles which lead to random behaviours when moving in shared areas. Moreover, their inertia is much lower than vehicles (for example a pedestrian can do a U turn in less than one second) and as such their motion dynamic is more difficult to predict.

The VBS enables the dissemination of VRU Awareness Messages (VAM), whose purpose is to create awareness at the level of other VRUs or vehicles, with the objective to solve conflicting situations leading to collisions. The vehicle possible action to solve a conflict situation is directly related to the time left before the conflict, the vehicle velocity, vehicle deceleration or lane change capability, weather and vehicle condition (for example state of the road and of the vehicle tyres). In the best case, a vehicle needs 1 to 2 seconds to be able to avoid a collision, but in worst cases, it can take more than 4 to 5 seconds to be able to avoid a collision. If a vehicle is very close to a VRU and with constant velocity (for example time-to-collision between 1 to 2 seconds), it is not possible any more to talk about awareness as this becomes really an alert for both the VRU and the vehicle.

VRUs and vehicles which are in a conflict situation need to detect it at least 5 to 6 seconds before reaching the conflict point to be sure to have the capability to act on time to avoid a collision. Generally, collision risk indicators (for example TTC, TDTC, PET, etc., see ETSI TS 103 300-2 [1]) are used to predict the instant of the conflict. These indicators need a prediction of:

- the trajectory (path) followed by the subject VRU and the subject vehicle;
- the time required by the subject VRU and the subject vehicle to reach together the conflict point.

These predictions should be derived from data elements which are exchanged between the subject VRU and the subject vehicle. For vehicles, the trajectory and time predictions can be better predicted than for VRUs, because vehicles' trajectories are constrained to the road topography, traffic, traffic rules, etc., while VRUs have much more freedom to move. For vehicles, their dynamics is also constrained by their size, their mass and their heading variation capabilities, which is not the case for most of the VRUs.

Accordingly, it is not possible, in many situations, to predict the VRUs exact trajectory or their velocity only based on their recent path history and on their current position. If this is performed, a lot of false positive and false negative results can be expected, leading to decisions of wrong collision avoidance action.

A possible way to avoid false positive and false negative results is to base respectively the vehicle and VRU path predictions on deterministic information provided by the vehicle and by the VRU (motion dynamic change indications) and by a better knowledge of the statistical VRU behaviour in repetitive contextual situations.

A prediction can always be verified a-posteriori when building the path history. Detected errors can then be used to correct future predictions.

---

## G.2 VRU Motion Dynamic Change Indications (MDCI)

VRU Motion Dynamic Change Indications are built from deterministic indicators which are directly provided by the VRU device itself or which result from a mobility modality state change (for example transiting from pedestrian to bicyclist, transiting from pedestrian riding his bicycle to pedestrian pushing his bicycle, transiting from motorcyclist riding his motorcycle to motorcyclist ejected from his motorcycle, transitioning from a dangerous area to a protected area, for example entering a tramway, a train, etc.).

In the present document, the VRUs were classified into four profiles which are defined in clause 4.1.

The SAE J3194 [i.9] also proposes a taxonomy and classification of powered micro-mobility vehicles:

- Powered bicycle.
- Powered standing scooter.
- Powered seated scooter.
- Powered self-balancing board.
- Powered skates.

Their main characteristics are their kerb weight, vehicle width, top speed, power source (electrical or combustion).

NOTE 1: Human powered micro-mobility vehicles (bicycle, standing scooter) should be also considered. Transitions between engine powered vehicles and human powered vehicles may occur, changing the motion dynamic of the vehicle. Both, human powered and engine powered may also occur in parallel, also impacting the motion dynamic of the vehicle.

In ETSI TS 103 300-2 [1] and in clause 5.4.2.6, a combined VRU is defined as the assembly of a VRU profile 1, potentially with one or several additional VRU(s), with one VRU vehicle or animal. Several VRU vehicle types are possible. Even if most of them can carry VRUs, their propulsion mode can be different, leading to specific threats and vulnerabilities:

- They can be propelled by a human (human riding on the vehicle or mounted on an animal).
- They can be propelled by a thermal engine. In this case, the thermal engine is only activated when the ignition system is operational.
- They can be propelled by an electrical engine. In this case, the electrical engine is immediately activated when the power supply is on (no ignition).

A combined VRU can be the assembly of one human and one animal (for example human with a horse or human with a camel). A human riding a horse may decide to get off the horse and then pull it. In this case, the VRU performs a transition from profile 2 to profile 1 with an impact on its velocity.

This diversity of VRUs and cluster association leads to several VBS state machines conditioning standard messages dissemination and their respective motion dynamics. These state machines and their transitions can be summarized as in Figure G.1.

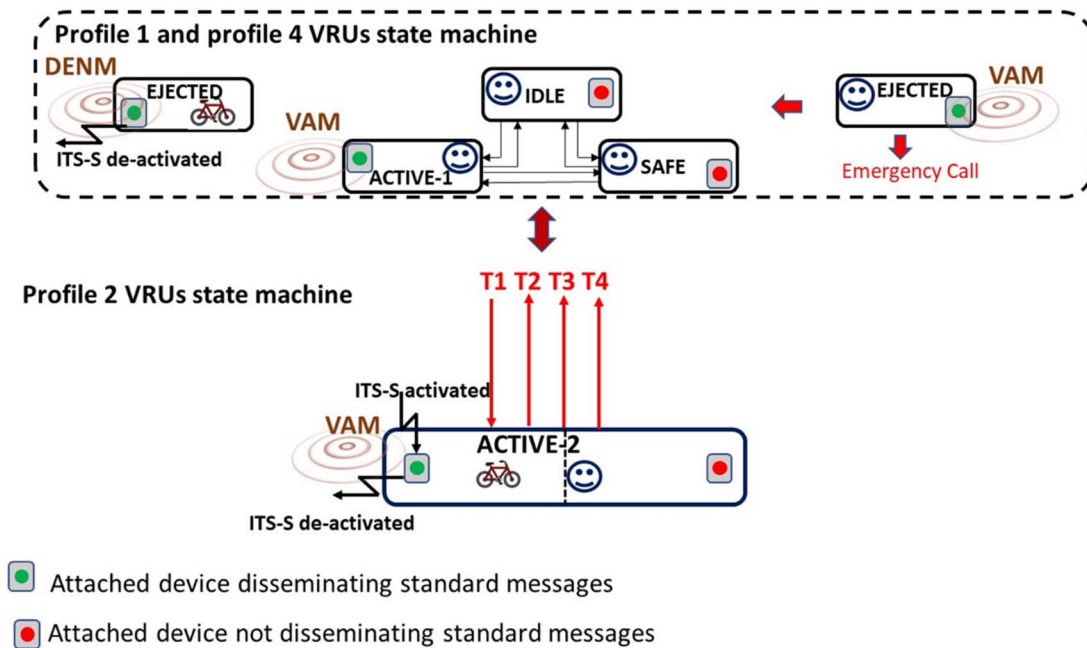

**Figure G.1: Overview of VBS state machines**

When a VRU is set as a profile 2 VRU, with multiple attached devices, it is necessary to select an active one. This can be achieved for each attached device at the initialization time (configuration parameter) when the device is activated. In Figure G.1, the device attached to the bicycle has been configured to be active during its combination with the VRU. But when the VRU returns to a profile 1 state, the device attached to the VRU vehicle needs to be deactivated, while the VBS in the device attached to the VRU transmits again VAMs if not in a protected location.

**NOTE 2:** In the future, profile 2, profile 1 and profile 4 VRUs may become members of a cluster, thus adding to their own state the state machine associated to clustering operation. This means that they need to respect the cluster management requirements while continuing to manage their own states. When transitioning from one state to another, the combined VRU may leave a cluster if it does not comply anymore with its requirements.

The machine states' transitions which are identified in Figure G.1 (T1 to T4) impact the motion dynamic of the VRU. These transitions are deterministically detected consecutively to VRU decisions or mechanical causes (for example VRU ejection from its VRU vehicle). The identified transitions have the following VRU motion dynamic impacts.

#### **T1: Transition from a VRU profile 1 to profile 2**

This transition is manually or automatically triggered when the VRU takes the decision to use actively a VRU vehicle (riding). The motion dynamic velocity parameter value of the VRU changes from a low speed (pushing/pulling his VRU vehicle) to a higher speed related to the class of the selected VRU vehicle.

#### **T2: Transition from a VRU profile 2 to profile 1**

This transition is manually or automatically triggered when the VRU gets off his VRU vehicle and leaves it to become a pedestrian. The motion dynamic velocity parameter value of the VRU changes from a given speed to a lower speed related to the class of the selected VRU vehicle.

#### **T3: Transition from a VRU profile 2 to profile 1**

This transition is manually or automatically triggered when the VRU gets off his VRU vehicle and pushes/pulls it for example to enter a protected environment (for example tramway, bus, train). The motion dynamic velocity parameter value of the VRU changes from a given speed to a lower speed related to the class of the selected VRU vehicle.

#### **T4: Transition from a VRU profile 2 to profile 1**

This transition is automatically triggered when a VRU is detected to be ejected from his VRU vehicle. The motion dynamic velocity parameter value of the VRU changes from a given speed to a lower speed related to the VRU state resulting from his ejection. In this case, the VRU vehicle is considered as an obstacle on the road and accordingly should disseminate DENMs until it is removed from the road (its ITS-S is deactivated).

NOTE 3: The ejection case can be detected by stability indicators including inertia sensors and the rider competence level derived from its behaviour. The stability can then be expressed in terms of the risk level of a complete stability lost. When the risk level is 100 % this can be determined as a factual ejection of the VRU.

NOTE 4: From the variation of the motion change dynamic velocity parameter value, a new path prediction can be provided from registered "contextual" past path histories (average VRU traces). The contextual aspects consider several parameters which are related to a context similar to the context in which the VRU is evolving (see clause G.3 for more explanations).

Adding to the state transitions identified above, which may drastically impact the VRU velocity, the following VRU indications also impact the VRU velocity and/or the VRU trajectory (in addition to the parameters already defined in the VAM).

### **Stopping indicator**

The VRU or an external source (a traffic light being red for the VRU) may indicate that the VRU is stopping for a moment. When this indicator is set, it could also be useful to know the duration of the VRU stop. This duration can be estimated either when provided by an external source (for example the SPATEM information received from a traffic light) or when learned through an analysis of the VRU behaviour in similar circumstances.

### **Visibility indicators**

Weather conditions may impact the VRU visibility and accordingly change its motion dynamic. Even if the local vehicles may detect these weather conditions, in some cases, the impact on the VRU could be difficult to estimate by vehicles. A typical example is the following: according to its orientation, a VRU can be disturbed by a severe glare of the sun (for example, in the morning when the sun rises, or in the evening when sun goes down), limiting its speed.

---

## **G.3 VRU Behaviour learning aspects**

The collection of VRU data enables the possibility to learn and discover the VRU behaviour in many contexts which could be highly repetitive.

A lot of VRUs have repetitive itineraries every working day when going from home to work or to study and back when returning from their work/study places to homes. These itineraries may be supported by transport multi-modal segments mixing public transport means with personal transport facilities which can be the property of the VRU or rented/shared by multiple VRUs.

When repetitive itineraries exist, whatever their purpose (work, studies, sport, shopping, etc.), the VRU traces (path histories) collected from the VRU motion may be recorded and classified according to contextual parameters (time of the day, travelled area, VRU profile and type, traffic level, weather conditions, VRU habits and specific behaviours, etc.).

Then, when the VRU is in a context similar to those which have been stored in the past, it becomes possible to recover the average and standard deviation of the existing traces and transform them into path predictions. Figure G.2 shows an example of past traces recovery used for path prediction. Another method for path prediction (e.g. for bicycles) is based on sensors and vehicle dynamic models (and possibly machine learning).

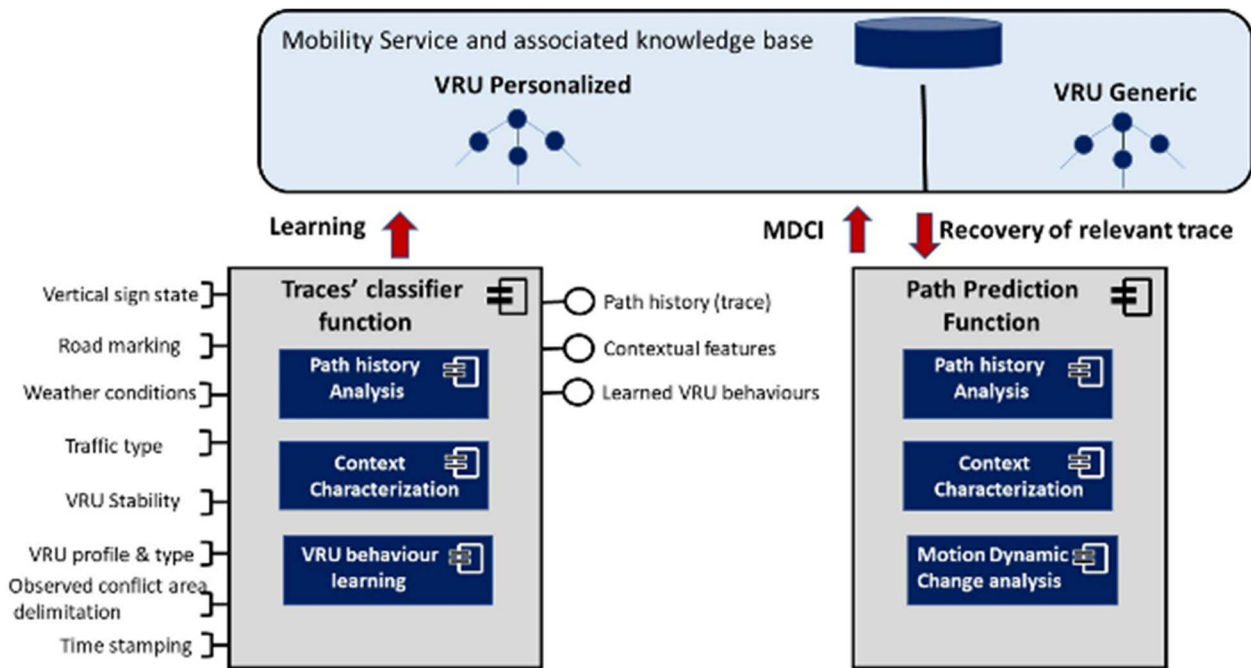

**Figure G.2: Example of past trace recovery for the elaboration of path prediction**

The provisioning of the VRU path prediction by the VRU device itself is one possibility for a receiving vehicle to predict with a certain level of trust the future path of the VRU and its associated velocity.

When remaining in a stable context (time, conflict area, VRU profile and type, etc.), the path prediction can be elaborated from similar past traces recorded. In case of the non-existence of such personalized traces, the path prediction could be elaborated from existing VRU generic traces showing similar contextual characteristics.

However, when a consistent motion dynamic change is detected, the elaboration of the path *prediction* needs to update its contextual characteristics (for example pedestrian becomes a bicyclist) and recover past traces corresponding to the new context.

When classifying contextual VRU traces, it is also possible to collect data about the VRU behaviour. An example is provided in Figure G.3.

In this figure, the VRU (a pedestrian or a bicyclist) leaves a shuttle every day at a given time (for example going to its work place). In the shuttle, the VRU is in a protected area and accordingly does not disseminate VAMs. As soon as it leaves the shuttle, the VRU enters a potential conflict area and has several possible paths (at least path 1 and path 2) to join his working place after crossing the two-way road. Path 1 is protected by a horizontal marking (zebra area) and a vertical sign (traffic light). Path 2 is not protected at all.

If the VRU respects the horizontal marking and vertical sign, he selects path 1 and its motion dynamic is impacted by the trajectory he follows and by the necessity to wait at the level of the traffic light, in case of a red sign for pedestrians/bicyclists. In this case, the impacts on approaching vehicles are different than if the VRU decided to follow path 2. Following path 1 means that vehicle V1 does not see the VRU (hidden by the shuttle) and needs to receive VAMs to secure this crossing, and that the vehicle V2 perceives the VRU who is protected by the traffic light.

If the VRU selects path 2, the vehicle V1 perceives the VRU while the VRU is hidden to vehicle V2 by the shuttle.

Accordingly, the disseminated VAMs are not analysed in the same manner by both vehicles, independently of the path selected by the VRU.

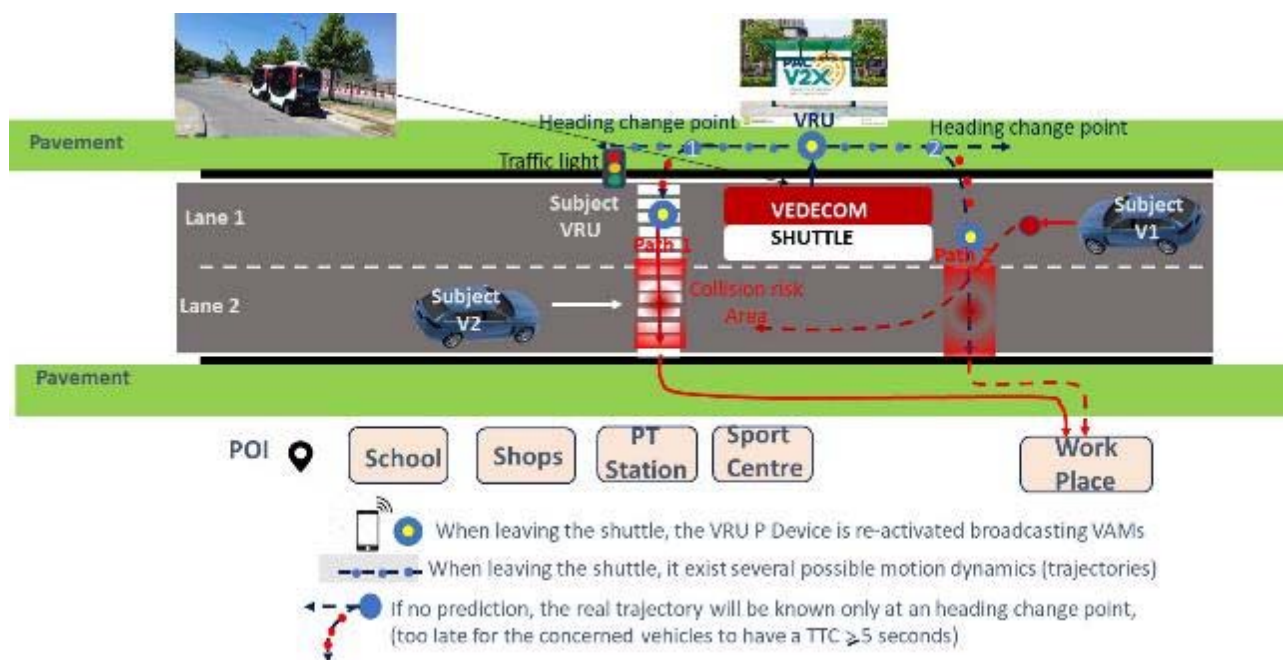

**Figure G.3: Example of possible different motion dynamics depending on the VRU behaviour**

This example presents a repetitive situation which may occur every working day at predefined time and place. By recording the VRU path history, every day, it may be derived:

- 1) the average path (trajectory) which is generally followed by the VRU;
- 2) if the path history is variable or not (random);
- 3) if the path history is constant, whether the VRU respects the horizontal marking and vertical signs allows to record the specific behaviour of the VRU, which could be reused in other situations.

**NOTE:** VRU recorded behaviour can be kept at the VRU attached device level for respecting his privacy. This should also be used carefully, as it may be subject to liability concerns in case the VRU changes his behaviour and an accident happens.

---

## Annex H (informative): Application to use case UC-B1: Active Roadworks

This annex provides indications on how to make use of the VBS in the use case UC-B1 "Active Roadwork" described in ETSI TR 103 300-1 [i.1]. Using the VBS and the broadcasting of VAMs would enable a finer granularity to locate the different workers together with a DENM, as defined in current application profiles. The mix of infrastructure-based installations, for example R-ITS-S, (broadcasting the DENM based on a digital fencing of the road work zone) and VRU devices can be envisioned.

- Road workers equipped with VRU devices sending VAM do not send CAM anymore (as specified in ETSI TS 103 300-2 [1]).
- They would not be involved in any cluster, as their movements are probably not coherent (except in some specific moments of their work).
- When inside the roadworks vehicle, they are not VRUs anymore. They are VRUs only when working on the road.
- They transmit a VRU profile 1 in the VAM.
- They transmit a specific sub-profile "road workers" (in that case, the confidence in the sub-profile is very high as they would handle a professional device), Another equivalent sub-profile of VRU profile 1 can be defined for first responders (police, firefighters, etc.).
- The size of the VAM should be minimized to avoid consuming all the VRU device batteries.
- It would make it more reliable to filter potential false warnings at the receiver side if DENM and VAM are used together and received by vehicles or VRUs. For example, if there is a DENM to indicate that there is a road work area ahead in addition to VAMs from those road workers (with simple information as suggested above), any ITS-Ss that receives the two types of messages can be confidently aware of VRU the road workers wherever they are positioned, whether inside or outside the road work zone.

**NOTE:** When operating the VBS, VRU devices would need to ensure data protection, guarantee the quality and robustness of localization and take into account the very crucial limitations to battery life. For example, an acoustic warning signal should be triggered if the VRU device runs below a pre-determined level of its battery.

---

# Annex I (informative): Non VRU ITS-S VAM Dissemination

## I.1 Introduction

Vulnerable Road User Awareness Messages (VAMs) are messages transmitted from VRU ITSs to create and maintain awareness of vulnerable road users participating in the VRU system. A VAM contains status and attribute information of the originating VRU ITS-S. The content may vary depending on the profile of the VRU ITS-S. A typical status information includes time, position, motion state, cluster status, and others. Typical attribute information includes data about the VRU profile, type, dimensions, and others. The generation, transmission and reception of VAM are managed by the VRU Basic Service (VBS). The VRU basic service is a facilities layer entity that operates the VAM protocol. It provides three main services: handling the VRU role, sending and receiving of VAMs to enhance VRU safety. It also specifies the VRU clustering concept in presence of high VRU density to reduce VAM communication overhead. In VRU clustering, closely located VRUs with coherent speed and heading form a facility layer VRU cluster and only cluster head VRU transmits the VAM. Other VRUs in the cluster skips VAM transmission. Active VRUs (not in VRU cluster) send individual VAM (called Single VRU VAM).

The VAM originated from VRU ITS-s does not address awareness of non-equipped VRUs (that is, VRUs without any ITS-S for Tx, Rx or both Tx/Rx) effectively. In many crowded situations such as busy intersection, zebra crossing, school drop off and pick up area, public bus stops, school bus stops, busy crossing near shopping mall, construction work area, and others, both equipped and non-equipped VRUs will be present. Cluster formation and management by an individual VRU ITS-S (as the cluster-leader) is limited by the available resources (computational, communication, sensing) VRU cluster formed by an individual VRU cannot include non-equipped VRUs in the cluster. In such cases, the VRUs should be able to decode and interpret the Collective Perception Message (CPM) to obtain the full environment awareness for safety. To this end, Infrastructure (such as R-ITS-S) can play a vital role in detecting (via sensors) potential VRUs and grouping them together into clusters in such scenarios including both equipped and non-equipped VRUs. For example, a static RSE may be installed at busy intersection, zebra crossing, school drop off and pick up area, busy crossing near shopping mall, and the like while a mobile RSE can be installed on designated vehicles (like school bus, city bus, service vehicle) to serve as infrastructure/RSE on public bus stops, school bus stops, construction work area, etc., for this purpose.

---

## I.2 Rationale

Existing VAM allows information sharing of either one ego-VRU or one VRU cluster. However, in case of non-VRU ITS-S (such as RSE or designated vehicles) VAM, non-VRU ITS-S may be able to detect one or more individual VRUs, and/or one or more VRU clusters in the FOV which need to be reported in the VAM. Modifications to the existing VAM format to enable non-VRU ITS-S VAM are presented. In a non-VRU ITS-S VAM, the VRU awareness contents of one or more VRUs and/or one or more VRU clusters are carried.

In addition, detailed mechanism of non-VRU ITS-S assisted VRU clustering including both equipped and non-equipped VRUs are considered where a non-VRU ITS-S (such as R-ITS-S) acts as a cluster leader and transmits non-VRU ITS-S VAM.

Reporting all detected VRUs and/or VRU clusters individually by non-VRU ITS can be very inefficient in certain scenarios such as presence of large number of VRUs or overlapping view of VRUs or occlusion of VRUs in the FOV of sensors at the originating non-VRU ITS-S. Such reporting via existing DFs/DEs in the VAM in case of large number of perceived VRUs and/or VRU clusters require large communication overhead and increased delay in reporting all VRUs and/or VRU clusters. Non-VRU ITS-S may need to use self-admission control, redundancy mitigation or self-contained segmentation to manage the congestion in the access layers. The self-contained segments are independent VAM messages and can be transmitted in each successive VAM generation events.



Therefore, an occupancy grid-based bandwidth efficient lightweight VRU awareness message could be supported to assist with large number of detected VRUs and/or VRU clusters or overlapping view of VRUs or occlusion of VRUs in the FOV. Value of each cell can indicate information such as presence/absence of a VRU, presence/absence of a VRU cluster, and even presence/absence of non-VRUs or other objects in the environment. Moreover, non-VRU ITS-Ss such as RSE have better perception of the environment (via sophisticated sensors) through Collective Perception Service (CPS) by exchange of Collective Perception Message (CPM) [4]. Since VRUs are not expected to be able to listen to CPMs and perceive the environment, non-VRU ITS-S can share light weight perceived environment information acquired from CPS to VRUs via VAM instead by adding corresponding DF and DEs.

### I.3 Light weight dynamic road occupancy map

Non-VRU ITS-Ss such as nearby R-ITS-S with advanced sensors or perception capabilities may also be able to create, maintain and share a dynamic road occupancy map with ego-VRU and the nearby VRUs as shown in Figure I.1. The dynamic road occupancy map is a predefined grid area of a road segment represented by Boolean values for the occupancy accompanied by corresponding confidence values. Since non-VRUs such as a nearby R-ITS-S may have better global view of the road segment it can be used for the management of VRU clustering and dissemination of multiple-VRU VAMs and multiple-VRU-cluster VAMs. Furthermore, the accurate environment perception, power availability, and computation capability of the non-VRU ITS-S could be leveraged for accurate environmental awareness and positioning of the VRUs and vehicles.

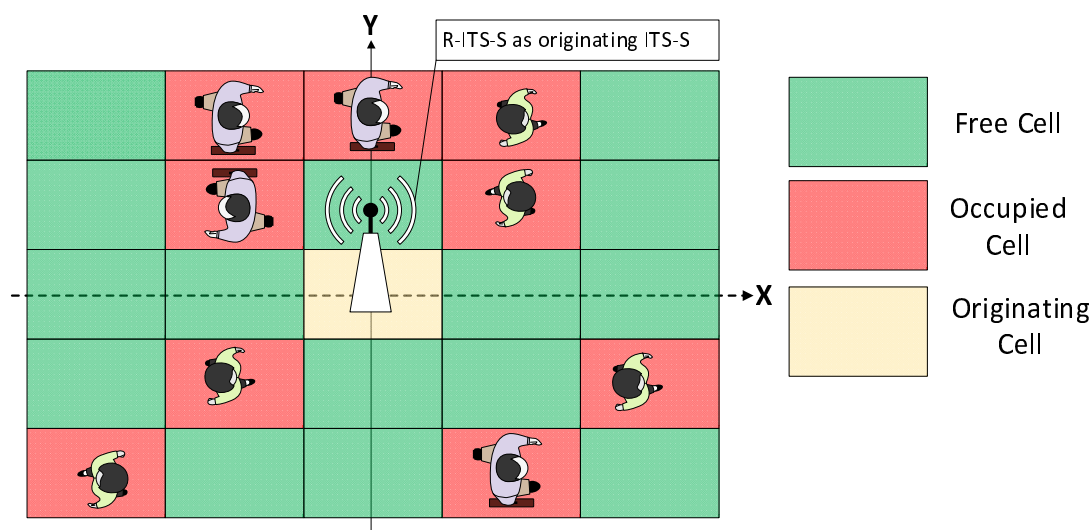

Figure I.1: Grid Occupancy Map concept shown for non-VRU ITS-S as the originating/ITS-S

#### Parameterization of grid map representation around the originating ITS-S

A rectangular shape for the grid is assumed as the baseline with a fixed shape for an individual grid as shown in Figure I.1. Moreover, a parameterization of the grid in terms of the following configuration parameters and details of the payload is proposed:

- 1) **Reference point:** Specified by the location of the originating ITS-S for the overall area.
- 2) **Grid/cell size:** Predefined global grid sizes specified by length and width of the grid assuming rectangular grid reflecting the granularity of the cells.
- 3) **Starting position of the cell:** Starting cell of the occupancy grid ( $P_{1,1}$ ) as shown in Figure I.2 as the reference grid. The other grid locations can be labelled based on offset from the reference grid.
- 4) **Bitmap of the occupancy values:** Boolean values representing the occupancy of each cell in the grid as shown in Figure I.2.
- 5) **Confidence values:** The confidence values corresponding to each cell in the grid (associated to the bitmap).

In addition to the above parameters, the mapping pattern of the occupancy grid into bitmap as shown in Figure I.2 are also specified.

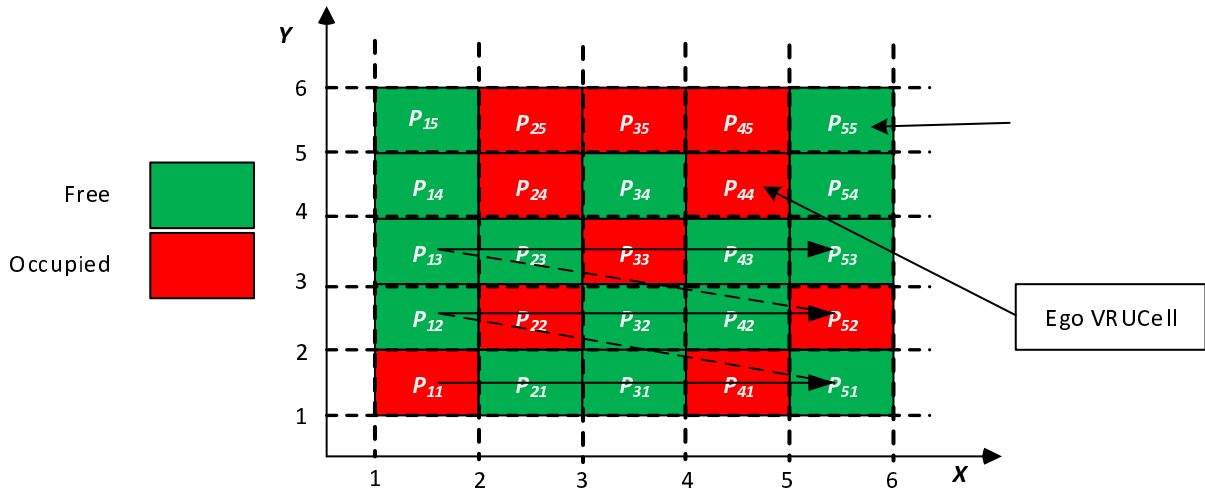

Figure I.2: Example Estimated Occupancy Map representation

## I.4 Text Proposal

### I.4.0 How to read this clause

The proposed new text to enable non-VRU ITS-S VAM dissemination is presented with "[[ ADD" and "]]".

### I.4.1 Update of clause 6.3: Transmitting VAMs

*"VRU ITS-S in VRU-ACTIVE-STANDALONE state shall send 'individual VAMs', while VRU ITS-S in VRU-ACTIVE-CLUSTERLEADER VBS state shall transmit 'Cluster VAMs' on behalf of the VRU cluster. Cluster member VRU ITS-S in VRU-PASSIVE VBS State shall send individual VAMs containing VruClusterOperationContainer while leaving the VRU cluster. VRU ITS-S in VRU-ACTIVE-STANDALONE shall send VAM as 'individual VAM' containing VruClusterOperationContainer while joining the VRU cluster."*

[[ ADD:

In some cases, non-VRU ITS-S (such as Static RSE or Mobile RSE on designated vehicles like school bus, construction work vehicle, police cars) may need to transmit a VAM (say Infrastructure VAM) specifically when non-equipped VRUs are detected. Such Infrastructure VAM may be transmitted for reporting either individual detected VRUs or cluster(s) of VRUs. Non-VRU ITS-S may select to transmit Infrastructure VAM reporting individual detected VRUs and cluster(s) of VRUs in the same Infrastructure VAM by including zero or more individual detected VRUs and zero or more clusters of VRUs in the same infrastructure VAM.

]]

## 1.4.2 Text for additional clause (to be inserted after clause 6.4.2): VAM Transmission Management by VBS at Non-VRU ITS-S

[[ ADD:

### 6.4.3 VAM Transmission Management by VBS at Non-VRU ITS-S

If Non-VRU ITS-S is not already transmitting consecutive (such as periodic) infrastructure VAM and the infrastructure VAM transmission does not subject to redundancy mitigation techniques, first time Infrastructure VAM should be generated immediately or at earliest time for transmission when any of the following conditions is satisfied:

- 1) At least one VRU is detected by originating Non-VRU ITS-S where the detected VRU has not transmitted VAM for at least  $T\_GenVamMax$  duration; the perceived location of the detected VRU does not fall in a bounding box of Cluster specified in any VRU Cluster VAMs received by originating Non-VRU ITS-S during last  $T\_GenVamMax$  duration; and the detected VRU is not included in any Infrastructure VAMs received by originating Non-VRU ITS-S during last  $T\_GenVamMax$  duration.
- 2) At least one VRU Cluster is detected by originating Non-VRU ITS-S where the Cluster head of the detected VRU Cluster has not transmitted VRU Cluster VAM for at least  $T\_GenVamMax$  duration; the perceived bounding box of the detected VRU cluster does not overlap more than a pre-defined threshold  $maxInterVRUClusterOverlapInfrastructureVAM$  with the bounding box of any VRU Clusters specified in VRU Cluster VAMs or Infrastructure VAMs received by originating Non-VRU ITS-S during last  $T\_GenVamMax$  duration.

Consecutive Infrastructure VAM Transmission is contingent to conditions as described here. Consecutive Infrastructure VAM generation events should occur at an interval equal to or larger than  $T\_GenVam$ . An Infrastructure VAM should be generated for transmission as part of a generation event if the originating non-VRU ITS-S has at least one selected perceived VRU or VRU Cluster to be included in current Infrastructure VAM.

#### 6.4.3.1 Perceived VRU inclusion Management in Current Non-VRU ITS-S VAM

The perceived VRUs considered for inclusion in current Infrastructure VAM should fulfil all these conditions:

- 1) originating Non-VRU ITS-S has not received any VAM from the detected VRU for at least  $T\_GenVamMax$  duration;
- 2) the perceived location of the detected VRU does not fall in a bounding box of VRU Clusters specified in any VRU Cluster VAMs received by originating Non-VRU ITS-S during last  $T\_GenVamMax$  duration;
- 3) the detected VRU is not included in any Infrastructure VAMs received by originating Non-VRU ITS-S during last  $T\_GenVamMax$  duration; and
- 4) the detected VRU does not fall in bounding box of any VRU clusters to be included in the current Infrastructure VAM by originating Non-VRU ITS-S.

A VRU perceived with sufficient confidence level fulfilling above conditions and not subject to redundancy mitigation techniques should be selected for inclusion in the current VAM generation event if the perceived VRU additionally satisfy one of the following conditions:

- 1) The VRU has first been detected by originating Non-VRU ITS-S after the last Infrastructure VAM generation event.
- 2) The time elapsed since the last time the perceived VRU was included in an Infrastructure VAM exceeds  $T\_GenVamMax$ .
- 3) The Euclidian absolute distance between the current estimated position of the reference point for the perceived VRU and the estimated position of the reference point for the perceived VRU lastly included in the Infrastructure VAM exceeds  $minReferencePointPositionChangeThreshold$ .

- 4) The difference between the current estimated ground speed of the reference point for the perceived VRU and the estimated absolute speed of the reference point for the perceived VRU lastly included in the Infrastructure VAM exceeds *minGroundSpeedChangeThreshold*.
- 5) The difference between the orientation of the vector of the current estimated ground velocity of the reference point for the perceived VRU and the estimated orientation of the vector of the ground velocity of the reference point for the perceived VRU lastly included in the Infrastructure VAM exceeds *minGroundVelocityOrientationChangeThreshold*.
- 6) The infrastructure or vehicles has determined that there is difference between the current estimated trajectory interception indication with vehicle(s) or other VRU(s) and the trajectory interception indication with vehicle(s) or other VRU(s) lastly reported in an infrastructure VAM.
- 7) One or more new vehicles or other VRUs (e.g. VRU Profile 3 - Motorcyclist) have satisfied the following conditions simultaneously after the lastly transmitted VAM. The conditions are: coming closer than Minimum Safe Lateral Distance (MSLaD) laterally, coming closer than Minimum Safe Longitudinal Distance (MSLoD) longitudinally and coming closer than Minimum Safe Vertical Distance (MSVD) vertically to the VRU after the lastly transmitted Infrastructure VAM.

#### 6.4.3.2 Perceived VRU Cluster inclusion Management in Current Non-VRU ITS-S VAM

The perceived VRU Clusters considered for inclusion in current Infrastructure VAM should fulfil all of the following conditions:

- 1) The perceived bounding box of the detected VRU cluster does not overlap more than *maxInterVRUClusterOverlapInfrastructureVAM* with the bounding box of VRU Cluster specified in any of the VRU Cluster VAMs or Infrastructure VAMs received by originating Non-VRU ITS-S during last *T\_GenVamMax* duration.

A VRU Cluster perceived with sufficient confidence level fulfilling above conditions and not subject to redundancy mitigation techniques should be selected for inclusion in the current VAM generation if the perceived VRU Cluster additionally satisfy one of the following conditions:

- 1) The VRU Cluster has first been detected by originating Non-VRU ITS-S after the last Infrastructure VAM generation event.
- 2) The time elapsed since the last time the perceived VRU Cluster was included in an Infrastructure VAM exceeds *T\_GenVamMax*.
- 3) The Euclidian absolute distance between the current estimated position of the reference point of the perceived VRU Cluster and the estimated position of the reference point of the perceived VRU Cluster lastly included in an Infrastructure VAM exceeds *minReferencePointPositionChangeThreshold*.
- 4) The difference between the current estimated Width of the perceived VRU Cluster and the estimated Width of the perceived VRU Cluster included in the lastly transmitted VAM exceeds *minClusterWidthChangeThreshold*.
- 5) The difference between the current estimated Length of the perceived VRU Cluster and the estimated Length of the perceived VRU Cluster included in the lastly transmitted VAM exceeds *minClusterLengthChangeThreshold*.
- 6) The difference between the current estimated ground speed of the reference point of the perceived VRU Cluster and the estimated absolute speed of the reference point included in the lastly transmitted VAM exceeds *minGroundSpeedChangeThreshold*.
- 7) The difference between the orientation of the vector of the current estimated ground velocity of the reference point of the perceived VRU Cluster and the estimated orientation of the vector of the ground velocity of the reference point included in the lastly transmitted Infrastructure VAM exceeds *minGroundVelocityOrientationChangeThreshold*.
- 8) The infrastructure or vehicles determined that there is difference between the current estimated trajectory interception indication with vehicle(s) or other VRU(s) and the trajectory interception indication with vehicle(s) or other VRU(s) lastly reported in an Infrastructure VAM.

- 9) Originating Non-VRU ITS-S has determined to merge the perceived cluster with other cluster(s) after previous Infrastructure VAM generation event.
- 10) Originating Non-VRU ITS-S has determined to split the current cluster after previous Infrastructure VAM generation event.
- 11) Originating Non-VRU ITS-S has determined change in type of perceived VRU cluster (e.g. from Homogeneous to Heterogeneous Cluster or vice versa) after previous Infrastructure VAM generation event.
- 12) Originating Non-VRU ITS-S has determined that one or more new vehicles or non-member VRUs (e.g. VRU Profile 3 - Motorcyclist) have satisfied the following conditions simultaneously after the lastly transmitted VAM. The conditions are: coming closer than Minimum Safe Lateral Distance (MSLaD) laterally, coming closer than Minimum Safe Longitudinal Distance (MSLoD) longitudinally and coming closer than Minimum Safe Vertical Distance (MSVD) vertically to the Cluster bounding box after the lastly transmitted InfrastructureVAM.

]]

### 1.4.3 Additional clause after clause 7.3.6: VAM Extension container

[[ ADD:

#### 7.3.7 VAM Extension container

The VRU Extension container of type *VamExtension* should carry VRU low frequency, VRU high frequency, cluster information container, cluster operation container, motion prediction container for each of the VRU and VRU Clusters reported in a non-VRU ITS-S originated VAM. Extension additionally carry *totalIndividualVruReported*, *totalVruClusterReported*, *VruRoadGridOccupancy* containers for in a non-VRU ITS-S originated VAM.

- The Road Grid Occupancy DF is of type *VruRoadGridOccupancy* and should provide an indication of whether the cells are occupied (by another VRU ITS-station or object) or free. The indication should be represented by the *VruGridOccupancyStatusIndication* DE and the corresponding confidence value of should be given by *ConfidenceLevelPerCell* DE. Additional DF/DE s are included for carrying the grid and cell sizes, road segment reference ID and reference point of the grid.

]]

### 1.4.4 Update of annex A (normative): ASN.1 specification of VAM

[[ ADD:

```

VamParameters ::= SEQUENCE {
    basicContainer                BasicContainer,
    vruHighFrequencyContainer     VruHighFrequencyContainer OPTIONAL,
    vruLowFrequencyContainer      VruLowFrequencyContainer OPTIONAL,
    vruClusterInformationContainer VruClusterInformationContainer OPTIONAL,
    vruClusterOperationContainer  VruClusterOperationContainer OPTIONAL,
    vruMotionPredictionContainer  VruMotionPredictionContainer OPTIONAL,
    vamExtensionsNonVruItsStation VamExtensionNonVruItsStation OPTIONAL,
    ...
}

--Only present for Non-VRU ITS-S Originated VAM
VamExtensionNonVruItsStation ::= SEQUENCE {
    totalIndividualVruReported TotalIndividualVruReported OPTIONAL,
    totalVruClusterReported   TotalVruClusterReported   OPTIONAL,
    vamParametersNonVruItsStation SEQUENCE (SIZE(1..Max))VamParametersNonVruItsStation OPTIONAL,
    -- Max is an integer value such as 64 or 128
    roadGridOccupancy          VruRoadGridOccupancy   OPTIONAL, -- defined below
    ...
}

-- Total individual VRUs reported in this VAM

```

```

totalIndividualVRUReported ::= INTEGER( 1..Max) - Max is maximum VRUs included in single VAM such as
32 or 64
-- Total VRU Clusters reported in this VAM
totalVRUClusterReported ::= INTEGER( 1..Max) --- Max is maximum VRU Clusters included in single
VAM such as 32 or 64

```

```

VamParametersNonVruItsStation ::= SEQUENCE {
    vruHighFrequencyContainer    VruHighFrequencyContainer,
    vruLowFrequencyContainer    VruLowFrequencyContainer OPTIONAL,
    vruClusterInformationContainer VruClusterInformationContainer OPTIONAL,
    vruClusterOperationContainer VruClusterOperationContainer OPTIONAL,
    vruMotionPredictionContainer VruMotionPredictionContainer OPTIONAL,
    ...
}

```

```

-- road grid occupancy related parameters and confidence
VruRoadGridOccupancy ::= SEQUENCE{
    roadsegmentID    RoadSegmentReferenceID, OPTIONAL, -- imported from ITS
    gridReferencePoint ReferencePosition, -- imported from ITS
    gridSize        GridSize    OPTIONAL,
    cellSize        GridSize    OPTIONAL,
    vruGridOccupancyStatusIndication VruGridOccupancyStatusIndication,
    confidenceLevelPerCell    ConfidenceLevelPerCell    OPTIONAL,
}

```

```

GridSize ::= SEQUENCE {
    gridLength    SemiRangeLength -- imported from ITS
    gridwidth     SemiRangeLength -- imported from ITS
}

```

```

VruGridOccupancyStatusIndication ::= SEQUENCE (Size(1..256,...)) OF BOOLEAN,
ConfidenceLevelPerCell           ::= SEQUENCE (Size(1..256,...)) OF ObjectConfidence,
-- imported from ITS
...

```

```

]]

```

---

# History

<b>Document history</b>		
V2.1.1	November 2020	Publication
V2.1.2	April 2021	Publication
V2.2.1	February 2023	Publication